

SCOPECORDER SERIES

DL850E / DL850EV



- Powerful mobile data acquisition recorders
- Measure & analyze dynamic behavior of electromechanical systems
- Flexible modular inputs for voltage, current, sensors and CAN/LIN bus
- Trend & Trigger on electrical power calculations (optional)

SCOPECORDER

For more information, please visit:

tmi.yokogawa.com

Test & Measurement Instruments

 3-Year Warranty 

Powerful data acquisition enables the research of dynamic behavior within your application



Measure and Analyze a wealth of signals in real-time and speed up development & fault finding

A ScopeCorder is a powerful portable data acquisition recorder that can capture and Analyze both transient events and trends up to 200 days. Using flexible modular inputs it combines the measurements of electrical and physical (sensor) signals, such as from CAN, LIN, and Serial buses and is also able to trigger on electrical power related calculations in real-time.

Flexible Inputs with Built-in Signal Conditioning

Choose from up to 17 input modules and gain a thorough insight into any application by synchronizing the measurement of multiple parameters.



- Voltage & Currents
- Sensor Outputs
- Temperature, Vibration / Acceleration, Strain, Frequency
- Logic Signals & CAN / LIN

- Application Benefits -

Precise measurement of fast switching signals even in the most harsh environments

Measure different types of electrical and physical signals simultaneously

A trustworthy platform for durability testing

Reduce time spent on fault finding by capturing transient signals even during long term measurements.

Real-time evaluation of dynamic behaviour within Power applications

Synchronization of measurement data from different remote locations.

- Supporting Feature -

Individually isolated and shielded input channels provide high-resolution, sample rates, and accuracy

Choose from 17 different types of input modules

Record measurements up to 200 days to internal hard disk

Powerful trigger functions with unique features such as Dual-Capture & History Memory

New power MATH trend calculations such as Active Power, Power Factor, Integrated Power and Harmonics

GPS or IRIG time synchronization

See page.2

See page.4

See page.6

See page.8

See page.7

Display and record vast amounts of data with continuous data recording into a hard disk drive in real time



10.4-inch LCD XGA (1024 x 768)
The large, high resolution LCD screen displays multiple channels in precise detail

Jog shuttle
Lets you easily set parameters with wide dynamic ranges

4 directional cursor keys
With large pop-up menus and 4 directional cursor keys, it is easy to enter and modify settings with many parameters.

One Button SAVE
Select data or image format you wish to save in advance, then simply press one button to save everything at once.

ALL CH key
A spreadsheet style view of all channel settings is displayed for easy editing.

Dedicated vertical axis and zoom knobs
Direct accessibility means faster and easier settings!

Panel sheets in your language
Select an adhesive sheet in any of 8 languages for the instrument's front panel

Snapshot key
Efficiency from Settings to Measurement, Analysis, and Saving

Analysis
Dedicated setup menu for real time analysis will be popped-up.

Large (2 GPoint) memory offers long duration measurement and two instantaneous zoom locations —2 GPoint memory (/M2 option)—

Comes standard with 250 MPoints of memory, expandable with 1 or 2 GPoint options. Large capacity memory does not simply provide longer durations of measurement.

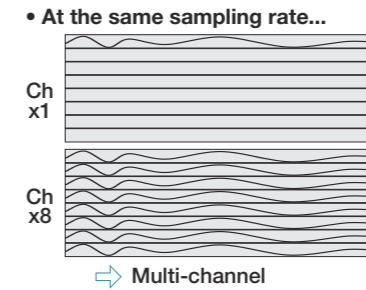
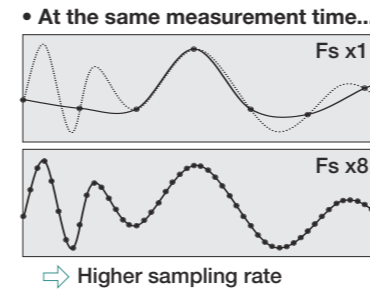

Measurements possible with a 2 GPoint long memory

Sample rate	With 1 ch	With 16 ch
100 MS/s	20 sec.	2 sec. (using 8 ch)
10 MS/s	3 min. 20 sec.	10 sec.
1 MS/s	30 min.	1 min. 40 sec.
100 kS/s	5 hours	10 min.
10 kS/s	50 hours	2 hours 30 min.
200 S/s	100 days	5 days
100 S/s	200 days*	10 days

* 200 days is maximum.



Main screen: 20 days of recording (2 days/div)
Up to 2 million times!
Zoom screen: 1 hour (12 min/div) & 1 second (100 ms/div)

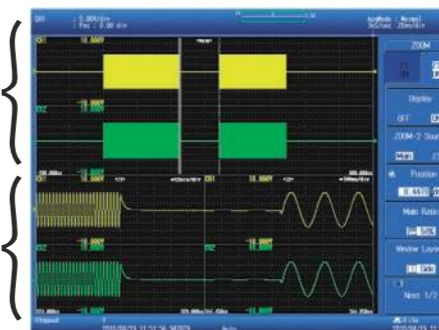

Instantly zooms 1 second (100 ms/div) even when the main screen is displaying 20 days of recording (2 days/div)

Long memory does not guarantee better efficiency if the memory handling and display engine is slow. Our faster than ever GiGAZoom 2 Engine instantaneously zooms into two locations.

Continuous data recording for durability test and/or surveillance test

Intuitive, user-friendly acquisition software comes standard. Continuous data recording into a PC Hard Disk Drive(HDD) can be performed by "free-run mode" with no restriction of recording time and file size.

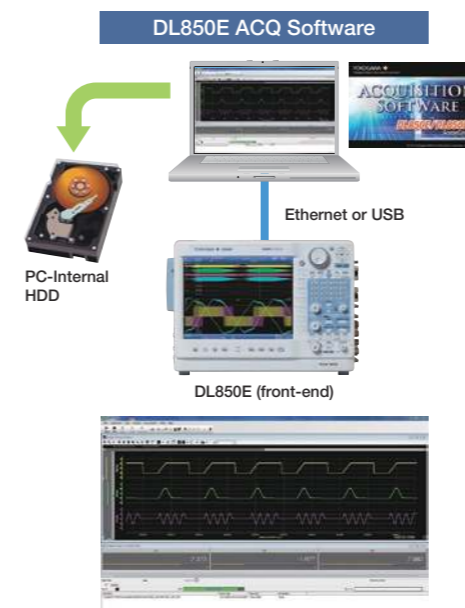

Setup Wizard Makes It Easy

The Wizard automatically recognizes any connected DL850E and its' plug-in modules. Just click the Start button to start measuring right away--no complicated settings to enter. The five screens of the Setup Wizard guide you easily through detailed settings for configuring the system, measuring, saving and displaying. Of course, you can save and recall your settings at any time.



Real Time Waveform Display

You can display a zoomed portion of the waveform simultaneously with the overall waveform during triggered measurement. Even during live recording, you can use the display hold to review past data.

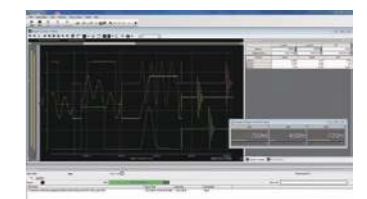

Long duration, continuous saving of waveforms —Hard disk recording (/HDO, /HD1 option)—

Measured data can be streamed directly to a built-in 500 GB hard disk (/HD1 option)*1 or through the external HDD interface (/HDO option)*1. With long periods of evaluation testing, measurements can be performed at 100 kS/s on 16 channels simultaneously for 10 hours*2.



100 kS/sec with 16 ch simultaneously

Sample rate	With 1 ch	With 16 ch
1 MS/s	10 hours	-
200 kS/s	60 hours	-
100 kS/s	5 days	10 hours
20 kS/s	20 days	2.5 days
2 kS/s	200 days*2	20 days

With the /M2 option, the maximum duration depends on the memory length.
* 2. Real time hard disk recording can be performed for a maximum of 200 days.

*1 The /HDO and /HD1 options cannot be specified together.
*2 It depends on the external hard disk connected when using the /HDO option.

A wide variety of unique acquisition features enables you to capture the target event easily



Capture high speed transients during long term recording using "Dual capture"

To visualize long term trends in durability testing and other similar applications, data is typically acquired at low-speed sample rates. In addition, it is also required to capture transient phenomena at high-speeds and high sample rates. The "Dual Capture" feature satisfies these requirements by recording at two different sampling rates.

Measurements with simultaneous high- and low-speed sampling



- Event waveform**
Displays the timing at which high speed capture waveforms are acquired
- Main waveform**
Max: 100 kS/s
Trend waveform displayed in a low-speed Roll mode
- Capture waveform**
Max 100 MS/s
Capture transients with high speed trigger measurement

Example: Parts durability testing
Parts used in automobiles and other transportation vehicles must be highly reliable. The "Dual Capture" function is very effective when performing vibration testing of connectors under varying temperatures.



Chattering is accurately captured at high-speed sampling. Check the frequency of occurrence at low-speed sampling

Zoom waveform

You can record up to 5,000 phenomena of high speed trigger measurements (up to 100 MS/s) at a record length of 5-500 kPoints while taking trend measurements at up to 100 kS/s.

You can recall past waveforms using "History Memory", so you'll never miss an abnormal waveform

When you spot an abnormal phenomenon during repetitive high speed measurements, often the anomaly has disappeared from the screen by the time you press Stop. Always active, the "History" function automatically divides the long memory into segmented (up to 5,000) "history waveforms" that can be redisplayed at any time.

Use the jog shuttle to display past waveforms

To extract abnormal waveforms...

To check the history...

You can display all past waveforms, and view a list of acquisition times.

Searching history waveforms

When you want to extract specific abnormal phenomena, you can perform condition-based searches inside the history waveforms. You can create a rectangular zone on screen and extract only waveforms that pass through or do not pass through the zone. You can also extract data based on parameters such as amplitude or RMS.

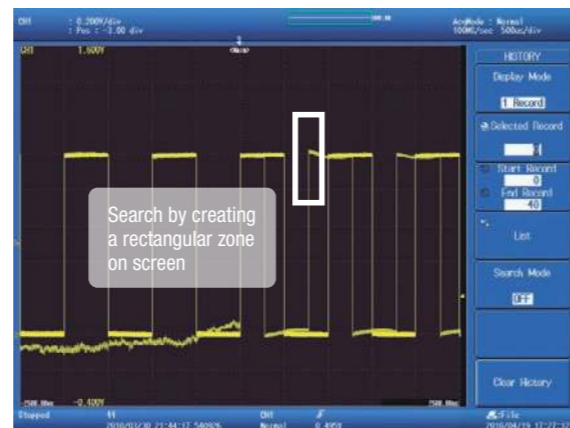

Key Point

The History function requires no action during measurement. You can recall data at any time after measurement has been completed. Once waveforms have been recalled, you can zoom locations of interest or perform parameter measurements.

Reduce time spent on fault finding or transient analysis

Simple & Enhanced triggers

Having the possibility to set individual triggers on multiple channels provides the power to investigate what causes a certain transient event. This also helps to analyze what the effect of such an event is to other parts within the application.



Example: "A delay B" trigger setup screen (After condition A becomes true, trigger the first time condition B becomes true after a set time has passed.)

Action On Trigger

Leave a ScopeCorder unattended and automatically save the waveform file or send an email for notification of a trigger event.

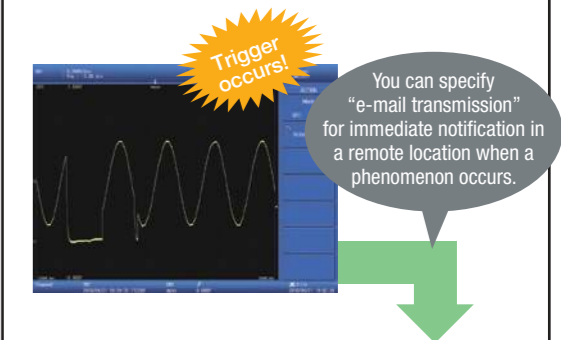

- Beep sounds
- Prints out screenshots
- Saves waveform data
- Saves screenshots
- Sends e-mails to a specified address

Wave Window Trigger

The ideal trigger for AC power line monitoring. Easily capture a voltage sag, interfering impulses, phase shift or drop out.

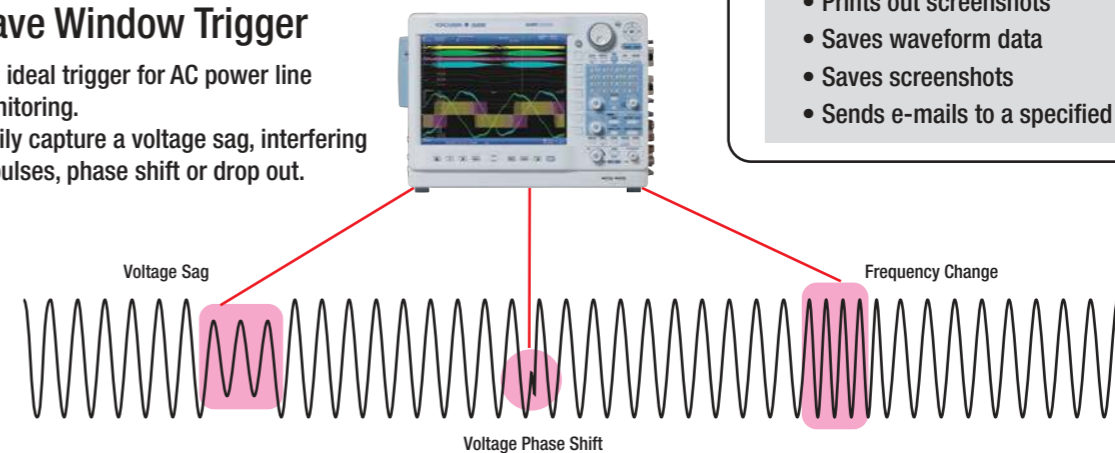

Time synchronization for accurate measurements

The internal time clock (date and time) can be synchronized and adjusted across multiple units. Applications are likely to include synchronizing the ScopeCorder at a windmill farm, finding faults in power grids, and more.

IRIG interface (/C20 option)

Synchronized measurement across multiple DL850 units is made possible by inputting an IRIG time code signal.

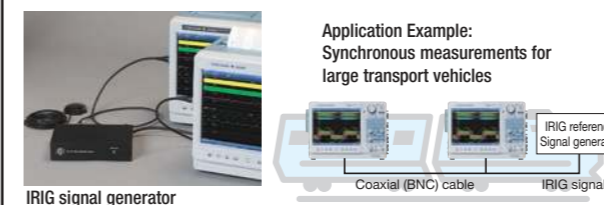

GPS interface (/C30 option)

A GPS antenna can be directly connected to the DL850E side panel. The DL850E time clock and the sampling clock can be adjusted accordingly.



Note: This option can be provided only for a nation that is not prohibited by the Radio Law.

Powerful data processing and Math

Interfaces and Software



Processes noise rejection and executes powerful computations in real time - /G3 option

The DL850E is armed with a dedicated DSP (digital signal processor) for computations that enables between-channel math during waveform capture. These between-channel computations are powerful because they can be set up separately from filter computations. In addition to FIR, IIR, Gauss, and moving average digital filters, you can choose from 37 unique functions such as arithmetic with coefficients, integrals and differentials, and higher-order equations.

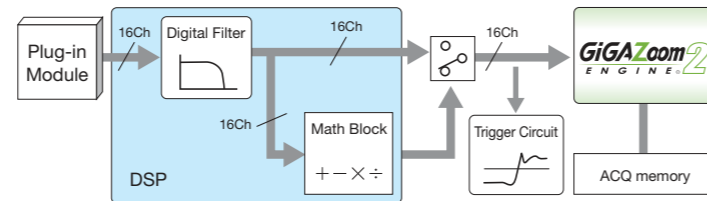

Trend waveform monitor for power and harmonic parameters in real time - /G5 option -

Max. 126-type power parameter can be calculated. The calculation results of these parameters can be displayed in DL850E screen as trend waveforms in real time. The raw signal waveforms along with calculated parameters(waveforms) can be displayed as trend waveforms with maximum data updating rate of 100kS/s. Trend waveforms of each orders of harmonics, bar-graphs and vector displays can be displayed.

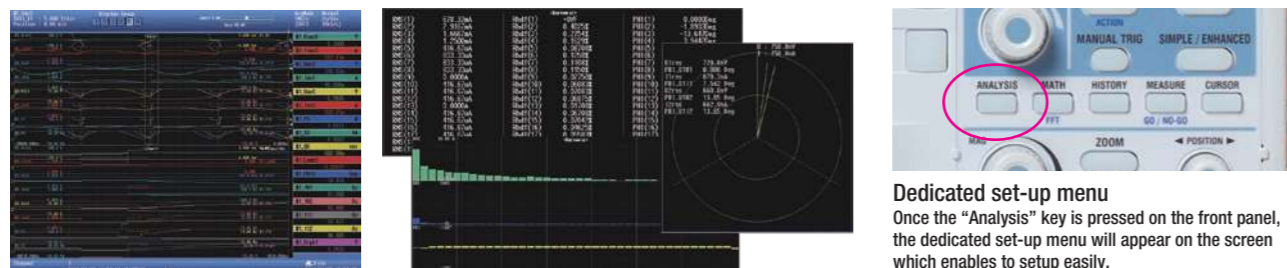

Dedicated set-up menu
Once the "Analysis" key is pressed on the front panel, the dedicated set-up menu will appear on the screen which enables to setup easily.

Application

6-input(3-voltage and 3-current) waveforms for 2-line, which are total 12 raw signal waveforms, can be monitored simultaneously along with max. 126-parameter/1-line (or 54-parameters/2-line) can be calculated.

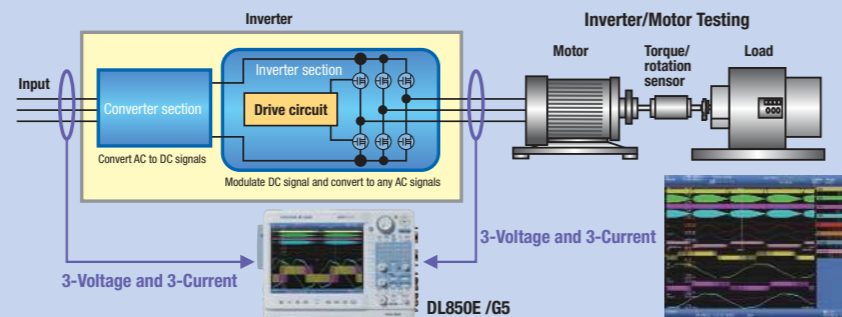

A wealth of functions gets you right to the waveform you want - User defined computation (/G2 option) -

The DL850E comes standard with arithmetic, time shift, FFT, and other computations that enable you to display waveforms with offsets and skew corrections. And with user defined computations (/G2 option), you can create equations using a combination of differentials and integrals, digital filters, and a wealth of other functions.

User defined computation setup screen



Example: Amplitude analysis using FFT

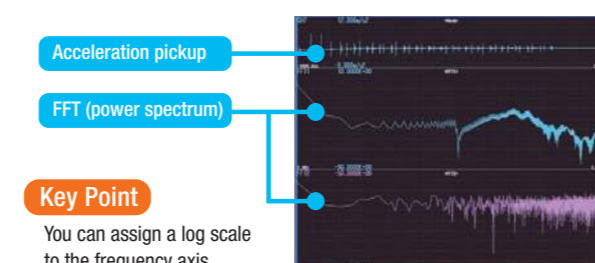

Variety of Connection Interfaces

- Video signal output (VIDEO OUT)**
Confirm waveforms on an analog RGB (XGA) external display.
- EXT I/O**
GO/NO-GO determinations can be output, and you can perform control based on start/stop and other external signals.
External I/O cable 720911
- External clock I/O (EXT CLK IN)**
Perform sampling timed to an external signal (up to 9.5 MHz).
- External trigger input**
- External trigger output**
- GP-IB (optional)**
- IRIG (optional²)**
Inputting an external time signal lets you synchronize multiple
- GPS (optional³)**
- Functional ground terminal**
- Probe power supply terminal (optional)**
- External hard drive IF (optional¹)**
Connect an eSATA standard hard drive.
- SD card slot**
SD, SDHC compliant, comes standard
- USB-PC connection terminal**
Enables control from a PC.
- USB peripheral connection terminal**
Supports USB storage, printer, keyboard and mouse input.
- Ethernet 1000BASE-T**
Comes standard

*1 Built-in hard disk and external hard disk IF are not available together.
*2 The GP-IB is also available when IRIG (/C20) option is specified.
*3 The GP-IB is not available when GPS(/30) option is specified.

PC Connectivity Options

On PCs
• Display can be monitored on the browser.
• Continuous data recording using the acquisition software.

DL850E/DL850EV
• A hard drive of the FTP server on the network can be selected as the save destination.
• Mail sending in automatic GO/NO-GO judgment.

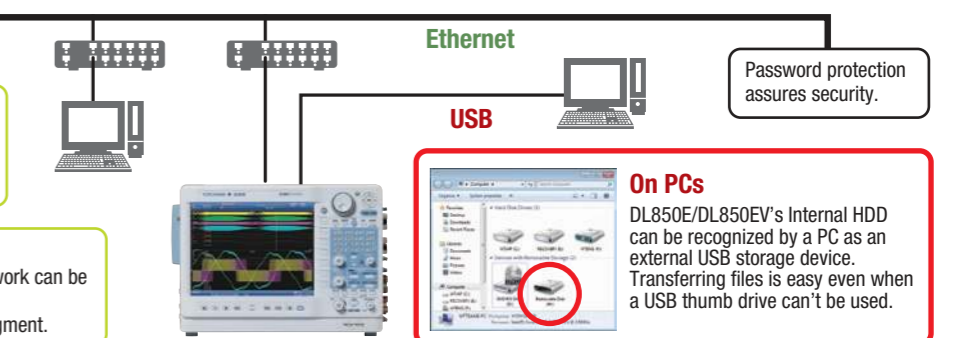

Software Control <http://tmi.yokogawa.com/ea/products/oscilloscopes/oscilloscopes-application-software/>

	Free Software	Optional Software Trial version available
Off-line waveform display and analysis	XviewerLITE -Basic check-Zoom, V-cursor, conversion to CSV format	DIAdem, LabVIEW DataPlugin*
Waveform monitoring on a PC	Web server	DL850E ACQ Software Continuous data recording
Data transfer to a PC	XWirepuller Remote monitor and operation Transferring image files.	
Command control Custom software development	Control library "TMCTL" For Visual Studio LabVIEW instrument driver	File Access Library
		Xviewer -Advanced Analysis- Advanced and useful functions are supported. Good for precise, off-line waveform analysis. <ul style="list-style-type: none"> Waveform observation and analysis Cursor, Parametric Measure Statistical Analysis Multiple file display Advanced waveform operations Comment, marking, printing and making report Optional Math computation feature Remote monitor Instruments communication function Transferring waveform & image files
		MATLAB Tool Kit Remote control from MATLAB and data file importing.

*: The DataPlugin software can be downloaded on National Instruments(NI) web site.

DL850EV VEHICLE EDITION

Enhanced capabilities for vehicle design and development such as CAN & LIN Buses monitoring

The DL850EV ScopeCorder Vehicle Edition can display CAN- and/or LIN-protocol communication data as trend waveforms on the display by using the CAN Bus Monitor Module (720240) or CAN & LIN Bus Monitor Module (720241).
By identifying the correlation between communication data on the vehicle-installed LAN and analog data such as voltage, temperature, and sensor signals or the ECU's control logic signal, a vehicle's overall LAN system can be evaluated.



[Example of comparison and verification of a measured signal and CAN bus signal]

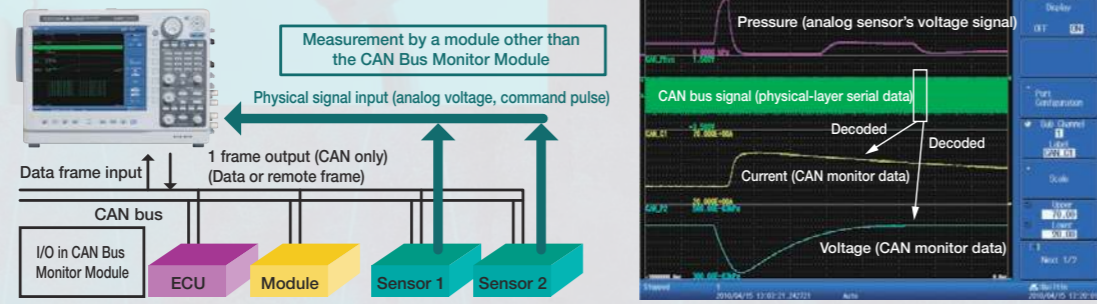

Data to be acquired using a bus monitor module (720240 or 720241) can be specified not only in digital code (hexadecimal or numeric), but also loaded from a network definition file (CAN DBC or LIN LDF).

Note: There is a certain restriction when using the 720240 and/or 720241 modules together with the /G5 option. Please contact our sales representative.

Support for both AC and DC power (/DC option, DL850EV only)

- Low power consumption of 60 - 120VA (typ.)
- Low noise compared to using an external inverter
- Can be driven by external DC power such as the vehicle's battery
12 V DC (10 - 18 V)
- Can also be driven by AC power.
100 V AC (100 - 120 V)
200 V AC (200 - 240 V)

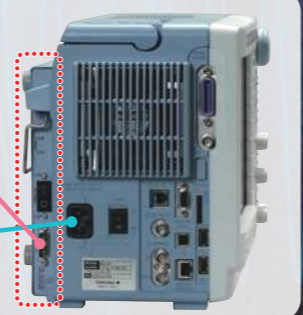

The DL850EV Vehicle Edition can be driven by a 12 V DC battery, vehicle's cigarette lighter, or ordinary AC power. (We provide accessories for DC driving; see the list of accessories at the end of the catalog.)

Applications



Motor, Inverter evaluation with noise-proof

- EV/HEV test
- Railways Motor characteristic test
- Home Appliance Inverter test
- Maintenance
- New Energy - Wind Power, Solar Power -
- Power transient analysis

- **ScopeCorder Solutions**
 - Realtime Power calculations
 - Multi-channel and continuous measurement (Power +)
 - 6-input (3-voltage and 3-current) waveforms for 2-system simultaneous measurement
 - Long memory • Isolation, 12-bit resolution, 100MS/s

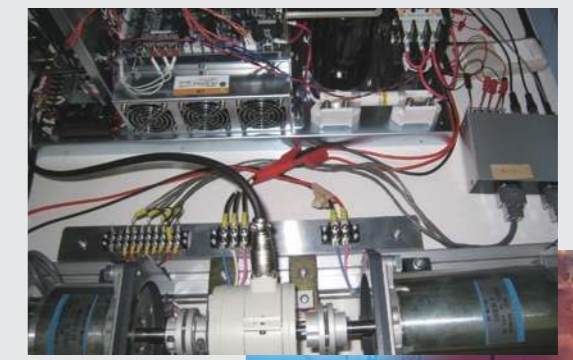

Vehicle testing including CAN/LIN

- Power steering evaluation
- In-Vehicle test
- Engine performance test
- ECU Test
- CVT test

- **ScopeCorder Solutions**
 - Rotary angle, Edge Count (/G3 option)
 - DC 12V power drive (option, DL850EV only)
 - CAN/LIN Data trend monitoring (DL850EV only)
 - Knocking Filter (DL850EV+/G3 option)

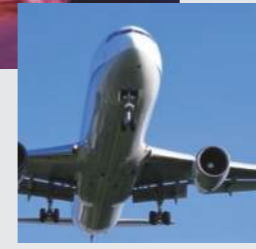

Durability test/ Surveillance test

- Test for a production line
- Durability test
- High-speed universal data logging

- **ScopeCorder Solutions**
 - Dedicated ACQ Software
 - Long-term HDD recording
 - Max. 128-CH measurements
 - GO/NO-GO determination

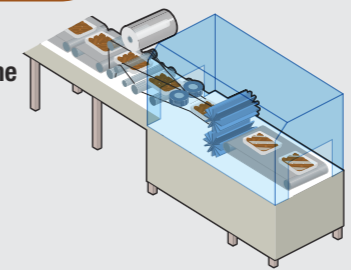

Time Synchronization Measurements

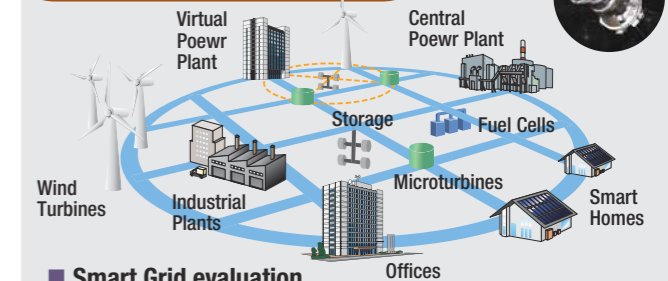

- Smart Grid evaluation
- Power swing test for multi-power site
- Railways driving test
- **ScopeCorder Solutions**
 - IRIG/GPS clock synchronization measurement

Precision Making & Makers
Recording Features
Acquisition Features
Math, Interface & Software
DL850EV & Applications
Module & Accessories
Specifications

Example of accessory combinations

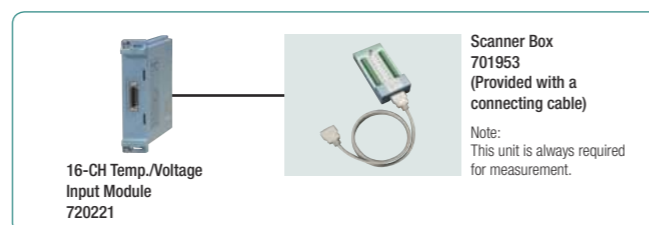
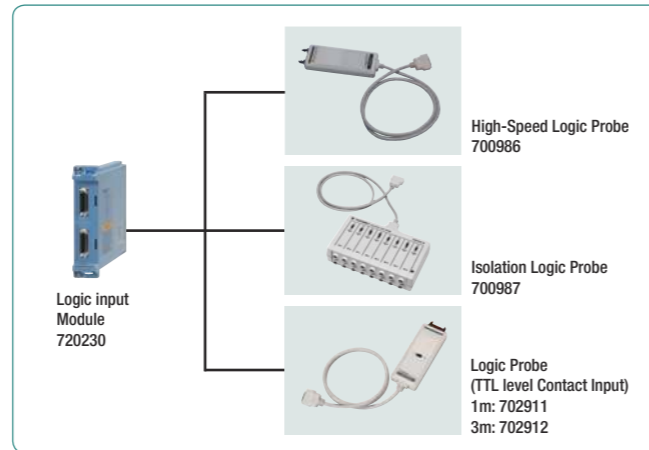
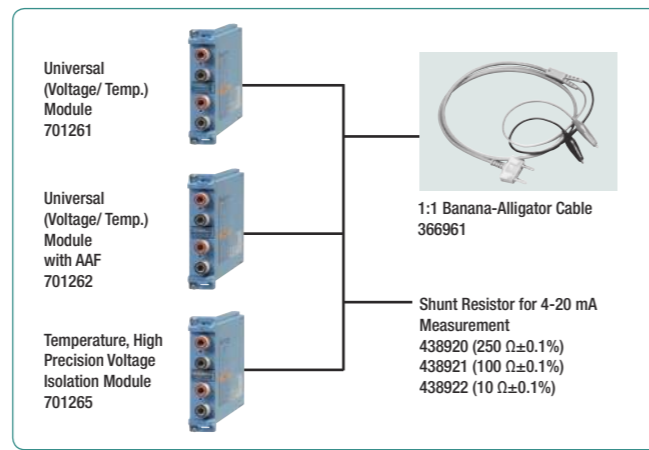
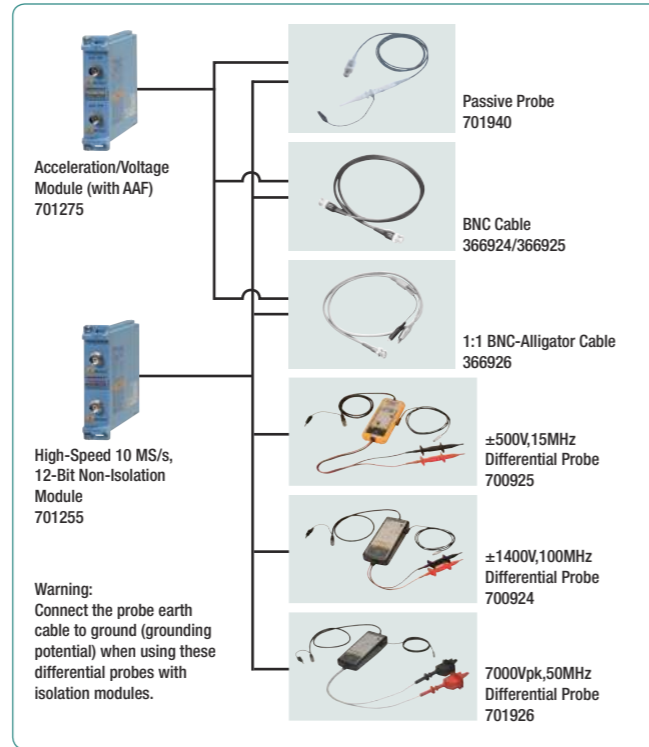
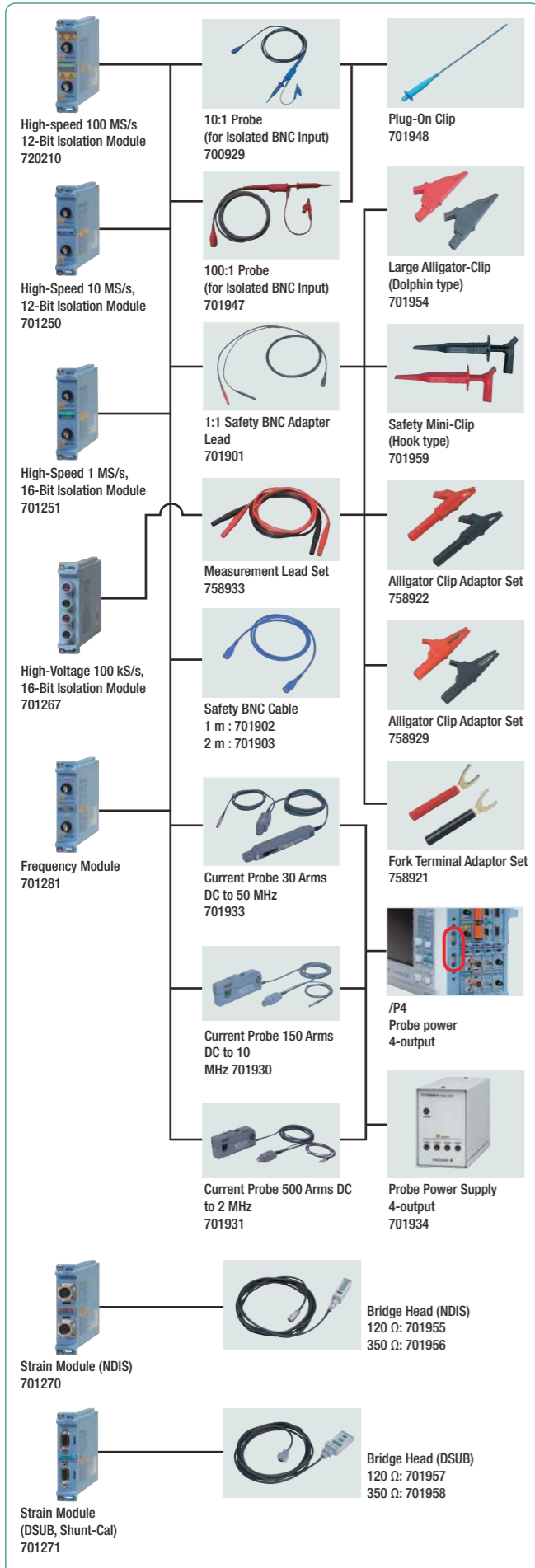

Module Selection

Input	Model No.	Sample Rate	Resolution	Bandwidth	Number of Channels	Isolation	Maximum Input Voltage (DC+ACpeak)	DC Accuracy	Note
Analog Voltage	720210 ⁹	100 MS/s	12-Bit	20 MHz	2	Isolated	1000 V ² 200 V ³	±0.5%	High speed · High voltage · Isolated Max. four (4) modules can be installed in a main unit. ⁶
	701250 ⁵	10 MS/s	12-Bit	3 MHz	2	Isolated	600 V ² 200V ³	±0.5%	high noise immunity
	701251	1 MS/s	16-Bit	300 kHz	2	Isolated	600 V ² 140 V ³	±0.25%	High sensitivity range (1mV/div), low noise (±100 μVtyp.), and high noise immunity
	701255 ⁵	10 MS/s	12-Bit	3 MHz	2	Non-Isolated	600 V ² 200V ³	±0.5%	non-isolation version of model 701250
	701267	100 kS/s	16-Bit	40 kHz	2	Isolated	850 V ³	±0.25%	with RMS, and high noise immunity
	720220	200kS/s	16-Bit	5 kHz	16	Isolated (GND-terminal) non-isolated (CH-CH)	42V ³	±0.3%	16CH voltage measurement (Scan-type)
Temperature	701261	100 kS/s (Voltage), 500 S/s (Temperature)	16-Bit (Voltage), 0.1: (Temperature)	40 kHz (Voltage), 100 Hz (Temperature)	2	Isolated	42 V	±0.25% (Voltage)	thermocouple (K, E, J, T, L, U, N, R, S, B, W, iron-doped gold/chromel)
	701262	100 kS/s (Voltage), 500 S/s (Temperature)	16-Bit (Voltage), 0.1: (Temperature)	40 kHz (Voltage), 100 Hz (Temperature)	2	Isolated	42 V	±0.25% (Voltage)	thermocouple (K, E, J, T, L, U, N, R, S, B, W, iron-doped gold/chromel), with AAF
	701265	500 S/s (Voltage), 500 S/s (Temperature)	16-Bit (Voltage), 0.1: (Temperature)	100 Hz	2	Isolated	42 V	±0.08 (Voltage)	thermocouple (K, E, J, T, L, U, N, R, S, B, W, iron-doped gold/chromel), high sensitivity range (0.1mV/div), and low noise (±4 μVtyp.)
	720221 ⁸	10 S/s	16-Bit	600 Hz	16	Isolated	42 V	±0.15% (Voltage)	16-CH voltage or temperature measurement (scan method) Thermocouple (K, E, J, T, L, U, N, R, S, B, W, Au-Fe-chromel)
Strain	701270	100 kS/s	16-Bit	20 kHz	2	Isolated	10 V	±0.5% (Strain)	Supports strain NDIS, 2, 5, 10 V built-in bridge power supply
	701271	100 kS/s	16-Bit	20 kHz	2	Isolated	10 V	±0.5% (Strain)	Supports strain DSUB, 2, 5, 10 V built-in bridge power supply, and shunt CAL
Analog Voltage, Acceleration	701275	100 kS/s	16-Bit	40 kHz	2	Isolated	42 V	±0.25% (Voltage) ±0.5% (Acceleration)	built-in anti-aliasing filter, Supports built-in amp type acceleration sensors (4 mA/22 V)
Frequency	701281	1 MS/s	16-Bit	Resolution 625ps	2	Isolated	420 V ² 42 V ³	±0.1% (Frequency)	Measurement frequency of 0.01 Hz to 500 kHz, Measured parameters (frequency, rpm, period, duty, power supply frequency, distance, speed)
Logic	720230	10 MS/s	—	—	8-bit x 2 ports	non-isolated	depend on logic probe used.	—	(8-bit/port) x 2, compatible with four-type of logic probe (sold separately)
CAN	720240	100 kS/s	—	—	{8signals/2} port	Isolated	10V	—	CAN Data of max. 32-bit allowable It is available for DL850EV only. Max two (2) modules can be installed in a main unit. ^{6,7}
CAN, LIN	720241	100 kS/s	—	—	{6signals/2} port	Isolated	10 V (CAN port) 18 V (LIN port)	—	CAN port x 1, LIN port x 1 Available for DL850EV only, up to 2 modules ^{6,7}

¹: Probes are not included with any modules. ²: In combination with 10:1 probe model 700929 ³: Direct input ⁴: In combination with 10:1 probe model 701940
⁵: Some of the models 701250/701255 shipped on or before July, 2007 may require factory rework. ⁶: Any other modules can be installed in the remaining slots.
⁷: Up to two CAN Bus Monitor Modules (720240) or CAN & LIN Bus Monitor Modules (720241) in total can be used on a single main unit. ⁸: The 16-CH Scanner Box (701953) is required for measurement.
⁹: Class 1 Laser Product, IEC60825-1:2007

For DL850E/DL850EV plug-in modules specifications, see the "Bulletin DL850E-01EN" catalog.

Related-Models



Mixed Signal Oscilloscope
DLM4000 series

- 8-CH analog inputs
- 350MHz or 500MHz bandwidth
- Max. 24-bit logic inputs are available



High-Speed Data Acquisition Unit
SL1000

- Stream data to PC with high speed
- 100MS/s, 16CH simultaneous measurement
- Supports parallel testing(Max. 8-unit)

Main Specifications (Main Unit)

Main Specifications (Main Unit)	Plug-in module
Input Section	Plug-in module
Number of slots	8 Max 4 for 720210 modules Max 2 modules for 720240, 720241 (for DL850EV only)
Number of input channels	DL850E: 16CH/Slot, 128CH/Unit DL850EV: 120CH/Slot, 336CH/Unit (Maximum simultaneous display waveform is 64 waveforms x 4 screen selectable)
Max recording length	Max recording length depends on kinds of modules and number of channels Standard 250 Mpts (1 CH), 10 Mpts/CH (16 CH ¹) /M1 option 1 Gpts (1CH), 50 Mpts/CH (16 CH ¹) /M2 option 2 Gpts (1CH), 100 Mpts/CH (16CH ¹) 1 pts (point) = 1 W (word)
Max Time axis setting range	100ns/div to 1s/div (1-2-5 step) 2s/div, 3s/div, 4s/div, 5s/div, 6s/div, 8s/div, 10s/div, 20s/div, 30s/div, 1min/div to 10min/div (1min step), 12min/div, 15min/div, 30min/div, 1h/div to 10h/div (1h step), 12h/div, 1day/div, 2day/div, 3day/div, 4day/div, 5day/div, 6day/div, 8day/div, 10day/div, 20day/div
Time axis accuracy ²	±0.005%

Trigger Section

Trigger mode	auto, auto level, normal, single, single (N), ON start
Trigger level setting range	0 centered ±10div
Simple trigger	
Trigger source	CH (n: any input channel), Time, External, Line
Trigger slope	Rising, falling, or rising/falling
Time trigger	Date (year/month/day), time (hour/minute), time interval (10 seconds to 24 hours)
Enhanced trigger	
Trigger source	CH (n: any input channel)
Trigger type	A→B(N), A Delay B, Edge on A, OR, AND, Period, Pulse Width, Wave Window

Display

Display	10.4-inch TFT color LCD monitor, 1024x768(XGA)
Display resolution of waveform display	selectable either 801x656 (normal waveform display) or 1001x656 (wide waveform display)
Display format	Max 3 simultaneous displays available In addition to main, 2 more waveforms available among zoom 1, zoom 2, XY1, XY2, FFT1, FFT2 (/G2 option), Vector (/G5 option), Bar graph (/G5 option)

Specifications (Main Unit)

Main Specifications (Main Unit)

Function	
● Acquisition and display	
Acquisition mode	Normal Envelope Normal waveform acquisition Maximum sample rate regardless of record time, holds peak value Averaging Average count 2 to 65536 (2n steps) Box average Increase A/D resolution up to 4 bits (max 16 bits)
Roll mode	It is effective when the trigger mode is set to auto/auto level/single/ON start, and time axis is greater than 100ms/div.
Dual capture	Performs data acquisition on the same waveform at 2 different sample rates.
Main waveform (low speed)	Maximum sample rate 100kS/s (roll mode region) Maximum record length 1G point (/M2, 1CH)
Capture waveform (high speed)	Maximum sample rate 100MS/s Maximum record length 500k point
Realtime hard disk recording (/HDD0/HD1 option)	Maximum sample rate Maximum 1MS/s (1CH used), 100kS/s (16CH used) depends on channel used Capacity Depends on HDD vacant capacity Action When waveform acquisition occurs according to the specified trigger mode, the DL850E/DL850EV stores the data to an internal hard disk or an external hard disk that supports eSATA.
History memory	Maximum 5000 waveforms
● Display	
Display format	TY display for 1, 2, 3, 4, 6, 8, 12, 16 division display
Maximum number of display traces	64 trace per 1 display group, selectable in every 4 displays
X-Y display	Selectable X axis/Y axis in CHn, MATHn (max 4 trace x 2 window)
Accumulation	Accumulates waveforms on the display (persistence mode)
Snapshot	Retains the current displayed waveform on the screen. Snapshot waveforms can be saved/loaded.
ALL CH menu	Set all channels while displaying waveforms. Operation using USB keyboard and USB mouse are available.
Expansion/reduction of vertical axis direction	x0.1 to x100 (varies depending on the module), DIV/SPAN set selectable
Vertical position setting	±5div waveform move is available from the center of waveform screen frame.
Linear scaling	Set AX+B mode or P1-P2 mode independently for CHn
● Analysis, computation	
Cursol measurement	Horizontal, Vertical, I, Marker, Degree (for T-Y waveform display only), H&V
Zoom	Expand the displayed waveform along time axis (up to 2 locations using separate zoom rates) Expanded display 100ns/div to 1/2 of Main waveform Auto scroll Automatically scrolls the zoom position.
Search and zoom	Search for, then expand and display a portion of the displayed waveform. Search conditions Edge count, logic pattern, event, time
History search function	Search for and display waveforms from the history memory that satisfies specified conditions. Zone search/parameter search
Waveform parameters items	Up to 32 items can be displayed P-P, Amp, Max, Min, High, Low, Avg, Mid, Rms, Sdev, +OvrShoot, -OvrShoot, Rise, Fall, Freq, Period, +Width, -Width, Duty, Pulse, Burst1, Burst2, AvgFreq, AvgPeriod, Int1TY, Int2TY, Int1XY, Int2XY, Delay(between channels)
Statistical processing	Automated measured values of waveform parameters
Statistics Mode	Max, Min, Avg, Sdv, Cnt
Mode	All waveforms/cycle statistics/history statistics
Maximum number of cycles	64,000 cycles (when the number of parameters is 1)
Maximum number of parameters	64,000
Maximum measurement range	100M points
Computation (MATH)	
Definable MATH waveforms	Max 8
Calculable record length	Max. 1M point (1ch)
Operators	+, -, ×, /, binary computation, phase shift, and power spectrum
User-defined computation	Computation setting is available by combining any following operators and parameter measurement items.
(/G2 option)	ABS, SQRT, LOG, EXP, NEG, SIN, COS, TAN, ATAN, PH, DIF, DDIF, INTG, IINTG, BIN, P2, P3, F1, F2, FV, PWHH, PWHL, PWLH, PWLL, PWXX, DUTYH, DUTYL, FILT1, FILT2, HLBT, MEAN, LS-, PS-, PSD-, CS-, TF-, CH-, MAG, LOGMAG, PHASE, REAL, IMAG
FFT	
Subject to be computed	CHn, MATHn
Number of channels	1 (/G2 no option), 2 (/G2 option)
Computation points	1k/2k/5k/10k/20k/50k/100k
Time window	Rect/Hanning/Hamming/FlatTop, Exponential (/G2 option)
Average function	Yes (/G2 option)

Real time MATH (/G3 option)	
Number of computation waveforms	Maximum 16 (Selectable with any input channel *)
Digital filter	Gauss (LPF), SHARP (LPF/HPF/BPF), IIR (LPF/HPF/BPF), MEAN (LPF)
Delay	100ns to 10.00ms (The data will be decimated when the delay time is relatively long.)
Types of computation	+, -, ×, /, four fundamental arithmetic operations with coefficients, differential, integral, angle, D-A conversion, quartic polynomial equation, rms value, active power value, Reactive power value, integrated power value, logarithm, square root, sin, cos, atan, electrical angle, polynomial addition & subtraction, frequency, period, edge count, resolver, IIR filter, PWM, knock filter (DL850EV only), and CAN ID (DL850EV only), Torque, S1-S2(Angle)
Power MATH(/G5*)	
Power Analysis	
Max. number of analyzable system	2-system (3-phase)
Max. number of measurement parameters	126 (1-system) 54 (2-system)
Wiring System	single-phase, two-wire; single-phase, three-wire; three-phase, three-wire; three-phase, four-wire; and three-phase, three-wire with three-voltage, three-current method
Delta Computation	3P3W Difference, 3P3W>3V3A 3P4W Star-Delta 3P3W(3V3A) Delta-Star
Measurement Items	RMS voltage/current of each phase, Simple voltage and current average (DC) of each phase, AC voltage/current component of each phase (AC), Active power, Apparent power, Reactive power, Power factor, Current phase difference, Voltage/Current frequency, Maximum voltage/current, Minimum voltage/current, Maximum/Minimum power, Integrated Power (positive and negative), Integrated Current (positive and negative), Volt-ampere hours, Var hours, Impedance of the load circuit, Series resistance of the load circuit, Series reactance of the load circuit, Parallel resistance of the load circuit, Parallel reactance of the load circuit, Unbalance rate of three-phase voltage, Unbalance rate of three-phase current, Motor output, Efficiency, Integration time
Harmonic Analysis	
Max. number of analyzable system	1-system
Max. analyzable frequency	1kHz (fundamental signal)
Number of FFT points	512
Wiring System	single-phase, two-wire; single-phase, three-wire; three-phase, three-wire; three-phase, four-wire; and three-phase, three-wire with three-voltage, three-current method
Delta Computation	3P3W Difference, 3P3W>3V3A 3P4W Star-Delta 3P3W(3V3A) Delta-Star
Measurement Mode	RMS Measurement mode, Power Measurement mode
Measurement Items	RMS Measurement mode: 1 to 40 order RMS, 1 to 40 order RMS distortion factor, 1 to 40 order phase difference, Total RMS, Distortion Factor (IEC), Distortion Factor (CSA) Power Measurement mode: 1 to 35 order active power, 1 to 35 order active power distortion factor, 1 to 35 order phase difference, Total active power, Total Apparent power, Total Reactive power, Power factor, 1st order RMS voltage, 1st order RMS current, 1st order voltage phase difference, 1st order voltage phase difference
GO/NO-GO determination	Operate selected actions based on the determination criteria to the captured waveform.
Zone	Determination using combination of up to 6 waveform zones (AND/OR).
parameters	Determination using combinations of 16 waveform parameters
Actions	Screen image data output, waveform data storage, buzzer notification, and e-mail transmission
Action-on trigger	Operates the selected actions each time trigger occurs.
Actions once triggered	Screen image data output, waveform data storage, buzzer notification, mail transmission
● Screen image data output	
Built-in printer (/B5 option)	Prints hard copy of screen.
External printer	Outputs the screen image to an external printer via Ethernet or USB
File output data format	PNG, JPEG, BMP
● Other functions	
Mail transmission function	Transmission function by SMTP
PROTECT key	Key protection is available to prevent from careless or unexpected operation.
NUM key	Direct input of numerical numbers is available.
Built-in printer (/B5 option)	
Printing system	Thermal line dot system
Paper width	112mm
Effective printing width	104mm (832 dot)

Main Specifications (Main Unit)

Feeding direction resolution	8dot/mm
Function	Display hard copy
Storage	
SD card slot	Memory cards conforms to SD, SDHC
USB memory	Mass storage device which conforms to USB Mass Storage Class Ver.1.1
External HDD(/HDD0 option)	Hard disc conforms to eSATA, FAT32
Built-in HDD(/HD1 option)	2.5 inch, 500GB, FAT32
USB peripheral interface	
Connector type	USB type A connector (receptacle) x 2
Electrical, mechanical specifications	Conforms to USB Rev.2.0*
Supported transmission standards	HS (High Speed) mode, FS (Full Speed) mode, LS (Low Speed) mode
Supported device	Mass storage device which conforms to USB Mass Storage Class Ver.1.1 109 keyboard, 104 keyboard, mouse which conform to USB HID Class Ver.1.1 HP(PCL) inkjet printer which conforms to USB Printer Class Ver.1.0
Power supply	5V, 500mA (in each port) * Connect USB device directly. Composite device is not supported.
USB-PC connection	
Connector type	USB type B connector (receptacle) x1
Electrical, mechanical specifications	Conforms to USB Rev.2.0
Supported transmission standards	HS(High Speed) mode (480Mbps), FS(Full Speed) mode (12Mbps)
Supported protocol	USBTMC-USB488 (USB Test and Measurement Class Ver.1.0)
Ethernet	
Connector type	RJ-45 modular jack x1
Electrical, mechanical specifications	Conforms to IEEE802.3
Transmission system	Ethernet (1000BASE-T/100BASE-TX/10BASE-T)
Communication protocol	TCP/IP
Supported services	Server FTP, Web, VXI-11 Client SMTP, SNTP, LPR, DHCP, DNS, FTP
GP-IB (/C1, /C20 option)	
Electrical specifications	Conforms to IEEE Std 488-1978(JIS C 1901-1987)
Functional specifications	SH1, AH1, T6, L4, SR1, RL1, PP0, DC1, DT0, C0
Protocol	Conforms to IEEE Std 488.2-1992
IRIG input (/C20 option)	
Connector type	BNC connector x1
Supported IRIG signals	A002, B002, A132, B122
Input impedance	50Ω/5kΩ selectable
Maximum input voltage	±8V
Function	Main unit time synchronization, sample block synchronization
Clock synchronization range	±80ppm
Accuracy after synchronization	No drift against input signal
GPS input (/C30 option)	
Connector type	SMA x1
Receiver type	GPS L1 C/A code SBAS: WAAS EGNOS MSAS
Function	Main unit time synchronization, Sample clock synchronization
Accuracy after synchronization	±200ns (when GPS signal is locked.)
Time for synchronization	Less than 5 minutes after booting
Antenna	Active antenna 3.3V power A1058ER (standard accessory)

Measurement Range and Display Range

The measurement range of the ScopeCorder is ±10 divisions (20 divisions of absolute width (span)) around 0 V. The display range of the screen is ±5 divisions (10 divisions of span). The following functions can be used to move the displayed waveform and display the waveform outside the display range by expanding/reducing the displayed waveform.

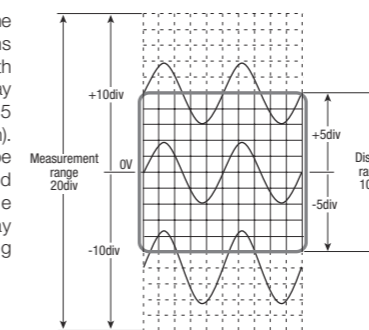

- Move the vertical position.
- Set the offset voltage.
- Zoom in or out of the vertical axis (expand/reduce).

Auxiliary I/O section	
EXT CLK IN	BNC connector, TTL level, minimum pulse width 50ns, 9.5MHz or less
EXT TRIG IN	BNC connector, TTL level, rising/falling
EXT TRG OUT	BNC connector, 5VCMOS level, fallen when triggered, and rising when acquisition completed.
EXT I/O	Connector type RJ-11 modular jack
GO/NO-GO determination I/O	Input level TTL or contact input output level 5V CMOS
External start/stop input	input level TTL or contact input
Manual event	input level TTL or contact input
Video signal output	D-Sub 15 pin receptacle Analog RGB, quasi XGA output 1024x768 dot, approx 60Hz Vsync
COMP output (probe compensation signal output terminal)	1kHz±1%, 1Vp-p±10%
Probe power output (/P4 option)	Number of terminals: 4, output voltage ±12V

General specifications	
Rated power supply voltage	100 to 120VAC/220 to 240VAC (automatic switching)
Rated power supply frequency	50/60Hz
Maximum power consumption	200VA
Withstand voltage	1500V AC between power supply and earth for 1 minute
Insulation resistance	10MΩ or higher at 500V DC between power supply and earth
External dimensions	Approx. 355mm (W) × 259 mm (H) × 180 mm (D), excluding handle and other projections
Weight	Approx. 6.5kg (for main unit only, include /B5/M2/HD1/P4 options, exclude chart paper)
Operating temperature range	5 to 40 °C

12 V DC power (/DC option, for DL850EV only)	
Supply method	Automatic DC/AC switching (with priority on AC), isolated between DC power input terminal and main unit
Rated supply voltage	12 V DC
Allowable supply voltage	10 to 18 V DC
Power consumption	Approx. 150 VA maximum
Voltage input protection circuit	Overcurrent detection: Breaker (15 A) Inverse connection protection: Breaker shutdown Undervoltage detection: Interruption at approx. 9.5 V or lower Overvoltage detection: Interruption at approx. 18 V or more
Withstand voltage	30 V AC between DC power terminal and ground for 1 min
Insulation resistance	10 MΩ or more at 500 V DC between DC power terminal and ground
External dimensions including the main unit	Approx. 355 mm (W) × 259 mm (H) × 202mm (D), excluding the grip and projections
Weight of DC power box	Approx. 800 g

Acquisition Software	
Number of connectable units	1 unit per 1 PC
Interface	USB, Ethernet
Functions	Recording Start/Stop, Monitoring, Setup control Data filing on a PC
Measurement mode	Free-run
Max. transmission rate	100KS/s(16CH)
Max. number of channels	336CH
Operation Conditions	OS: Windows7 (32bit / 64bit), Windows8 (32bit / 64bit) CPU: Intel Core 2 Duo(2GHz) or higher Memory: 1GB or more

Standard operation conditions	Ambient temperature: 23 ±5 °C Ambient humidity: 20 to 80 %RH Errors in power supply voltage/frequency: Within ±1% of rated voltage, within ±1% of rated frequency warm-up of 30 min. or more, after calibration.
-------------------------------	---

*1 Example when using the 2-CH Voltage Input Module (such as 701250). *2 Under the standard operating conditions.
*3 It is not possible to switch a channel associated with the 16-CH Voltage Input Module (720220), 16-CH Temp./Voltage Input Module (720221), CAN Bus Monitor Module (720240), and CAN & LIN Bus Monitor Module (720241) to real-time computation (/G3).
*4 The slot 7 and/or 8 cannot be used for signal measurement when the Power Analysis and/or Harmonic Analysis is activated.

Outline drawing (Unit: mm)

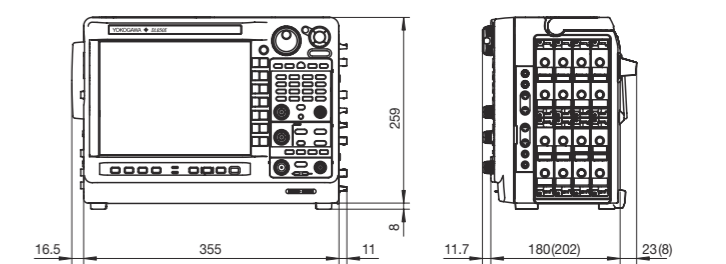

(case without /DC option)

Model/Suffix Code

Model	Suffix Codes	Description
DL850E		DL850E main unit, 250MPts(W) memory ¹
DL850EV		DL850EV main unit, 250MPts(W) memory ¹
Power Cord	-D	UL and CSA standard
	-F	VDE standard
	-R	AS standard
	-Q	BS standard
	-H	GB standard
Languages	-N	NBR standard
	-HE	English menu and panel
	-HJ	Japanese menu and panel
	-HC	Chinese menu and panel
	-HK	Korean menu and panel
	-HG	German menu and panel
Options	-HF	French menu and panel
	-HL	Italian menu and panel
	-HS	Spanish menu and panel
	/B5	Built-in printer (112mm) ⁵
	/DC	DC12 V power (10-18 V DC) (can be specified for DL850EV only) ⁵
	/M1	Memory expansion to 1Gpts(W) ²
	/M2	Memory expansion to 2Gpts(W) ²
	/HD0	External HDD interface ³
	/HD1	Internal HDD (500GB) ³
	/C1	GP-IB interface ⁴
	/C20	IRIG and GP-IB interface ⁴
	/C30	GPS interface ^{4,7}
	/G2	User-defined math function
/G3	Real time math function ⁵	
/G5	Power math function (with including Real time math function) ⁵	
/P4	Four probe power outputs	

*1: The main unit is not supplied with a plug-in module.

*2, *3, *4, *5, and *6: When selecting these, specify one of them.

*7: The /C30 option can be provided only for a nation that is not prohibited by the Radio Law.

Probes, Cables, and Converters

Product	Model No.	Description ¹
100:1 Probe (for Isolated BNC Input)	701947	1000 V (DC+ACpeak) CAT II
10:1 Probe (for Isolated BNC Input)	700929	1000 V (DC+ACpeak) CAT II
1:1 Safety BNC Adapter Lead (in combination with followings)	701901	1000 Vrms-CAT II
Safety Mini-Clip (Hook type)	701959	1000 Vrms-CAT II, 1 set each of red and black
Large Alligator-Clip (Dolphin type)	701954	1000 Vrms-CAT II, 1 set each of red and black
Alligator Clip Adaptor Set (Rated Voltage 1000 V)	758929	1000 Vrms-CAT II, 1 set each of red and black
Alligator Clip Adaptor Set (Rated Voltage 300 V)	758922	300 Vrms-CAT II, 1 set each of red and black
Fork Terminal Adapter Set	758321	1000 Vrms-CAT II, 1 set each of red and black
Passive Probe ²	701940	Non-isolated 600 Vpk (701255)(10:1)
1:1 BNC-Alligator Cable	366926	Non-isolated 42 V or less, 1m
1:1 Banana-Alligator Cable	366961	Non-isolated 42 V or less, 1.2m
Current Probe ³	701933	30 Arms, DC to 50 MHz, supports probe power
Current Probe ³	701930	150 Arms, DC to 10 MHz, supports probe power
Current Probe ³	701931	500 Arms, DC to 2 MHz, supports probe power
Probe Power Supply ⁴	701934	Large current output, external probe power supply (4 outputs)
Shunt Resistor	438920	250 Ω±0.1%
Shunt Resistor	438921	100 Ω±0.1%
Shunt Resistor	438922	10 Ω±0.1%
Differential Probe	700924	1400 Vpk, 1000 Vrms-CAT II
Differential Probe	700925	500 Vpk, 350 Vrms (For 701255)
Differential Probe	701926	7000Vpk, 5000Vrms
Bridge Head (NDIS, 120 Ω)	701955	With 5 m cable
Bridge Head (NDIS, 350 Ω)	701956	With 5 m cable
Bridge Head (DSUB, Shunt-CAL, 120 Ω)	701957	With 5 m cable
Bridge Head (DSUB, Shunt-CAL, 350 Ω)	701958	With 5 m cable
Safety BNC-banana Adapter	758924	500 Vrms-CAT II
Printer Roll Paper	B9988AE	For DL850E, DL850EV, 10 mx 10
Logic Probe ⁵	702911	8-Bit, 1 m, non-Isolated, TTL level/Contact Input
Logic Probe ⁵	702912	8-Bit, 3 m, non-Isolated, TTL level/Contact Input
High-speed Logic Probe ⁵	700986	8-Bit, non-Isolated, response speed: 1 μs
Isolated Logic Probe ⁶	700987	8-Bit, each channel isolated
Measurement Lead Set	758917	Measurement leads (2 per set) Alligator-Clip is required separately.
	758933	1000 V/19 A/1 m length Alligator-Clip is required separately.
Safety BNC-BNC Cable (1 m)	701902	1000 Vrms-CAT II (BNC-BNC)
Safety BNC-BNC Cable (2 m)	701903	1000 Vrms-CAT II (BNC-BNC)
External I/O Cable	720911	For external I/O connection
Plug-On Clip	701948	For 700929 and 701947
Long Test Clip	701906	For 700924 and 701926
Terminal	A1800JD	For 720220 input terminal, one (1) piece
Soft Carrying Case	701963	For DL850E/DL850EV
Connecting cables	705926	Connecting cable for 701953 (1 m)
	705927	Connecting cable for 701953 (3 m)
DC Power Supply Cable (Alligator clip type)	701971	For DL850EV DC 12 V Power
DC Power Supply Cable (Cigarette lighter plug type)	701970	For DL850EV DC 12 V Power
DC Power Supply Connector	B8023WZ	It comes standard with the /DC option
GPS antenna	A1058ER	It comes standard with the /C30 option

*1 Actual allowable voltage is the lower of the voltages specified for the main unit and cable.

*2 42 V is safe when using the 701940 with an isolated type BNC input.

*3 The number of current probes that can be powered from the main unit's power supply is limited.

*4 Any number of externally powered probes can be used.

*5 Includes one each of the B9879PX and B9879KX connection leads.

*6 Additionally, 758917 and either the 758922 or 758929 are required for measurement.

This is a Class A instrument based on Emission standards EN61326-1 and EN55011, and is designed for an industrial environment.

Operation of this equipment in a residential area may cause radio interference, in which case users will be responsible for any interference which they cause.

SCOPECORDER **isoPRO** **GIGAzoom** are trademarks of Yokogawa Electric Corporation.

* Any company's names and product names mentioned in this document are trade names, trademarks or registered trademarks of their respective companies.

The User's Manuals of this product are provided by CD-ROM.

Plug-in Module Model Numbers

Model	Description
720210	High-speed 100 MS/s 12-Bit Isolation Module (2 ch)
720220	Voltage Input Module(16 ch)
720221	16-CH Temperature/Voltage Input Module
701953-L1	16-CH Scanner Box (provided with 1 m cable)
701953-L3	16-CH Scanner Box (provided with 3 m cable)
720230	Logic Input Module (16 ch)
720240	CAN Bus Monitor Module (32 ch, available DL850EV only)
720241	CAN & LIN Bus Monitor Module
701250	High-speed 10 MS/s 12-Bit Isolation Module (2 ch)
701251	High-speed 1 MS/s 16-Bit Isolation Module (2 ch)
701255	High-speed 10 MS/s 12-Bit non-Isolation Module (2 ch)
701261	Universal Module (2 ch)
701262	Universal Module (with Anti-Aliasing Filter, 2 ch)
701265	Temperature/high-precision voltage Module (2 ch)
701267	High-voltage 100 kS/s 16-Bit Isolation Module (with RMS, 2 ch)
701270	Strain Module (NDIS, 2 ch)
701271	Strain Module (DSUB, Shunt-CAL, 2 ch)
701275	Acceleration/Voltage Module (with Anti-Aliasing Filter, 2 ch)
701281	Frequency Module (2 ch)

* Probes are not included with any modules.

Note 1: These modules can be used with the DL750/DL750P/SL1000 and SL1400 as well with some exceptions.

Note 2: Up to two 720240 or 720241 modules in total can be installed in a single DL850EV main unit.

Note 3: Max. four(4) 720210 modules can be installed in a main unit.

Note 4: The use of a 720221 module always requires the External Scanner Box (model 701953).

Xviewer model numbers and suffix codes

Model	Suffix Codes	Description
701992	-SP01	Xviewer Standard Edition (1 license)
	-GP01	Xviewer Math Edition (1 license)
Option	/JS01	DL850 Advanced Utility (1 license)

*: Some volume license packs are available. Please contact our sales representative.

Yokogawa's Approach to Preserving the Global Environment

- Yokogawa's electrical products are developed and produced in facilities that have received ISO14001 approval.
- In order to protect the global environment, Yokogawa's electrical products are designed in accordance with Yokogawa's Environmentally Friendly Product Design Guidelines and Product Design Assessment Criteria.

YOKOGAWA

YOKOGAWA METERS & INSTRUMENTS CORPORATION

Global Sales Dept. /Phone: +81-42-534-1413 Facsimile: +81-42-534-1426

E-mail: tm@cs.jp.yokogawa.com

YOKOGAWA CORPORATION OF AMERICA Phone: (1)-770-253-7000, Fax: (1)-770-254-0928

YOKOGAWA EUROPE B.V. Phone: (31)-88-4641000, Fax: (31)-88-4641111

YOKOGAWA ENGINEERING ASIA PTE. LTD. Phone: (65)-62419933, Fax: (65)-62412606

Subject to Change without notice.

Copyright©2010 Yokogawa Meters & Instruments Corporation.

[Ed : 02/b] Printed in Japan,406(KP)