

Keysight Technologies

E5071C ENA Network Analyzer

- 9 kHz to 4.5/6.5/8.5 GHz
- 100 kHz to 4.5/6.5/8.5 GHz (with bias tees)
- 300 kHz to 14/20 GHz (with bias tees)

E5092A Configurable Multiport Test Set

Data Sheet

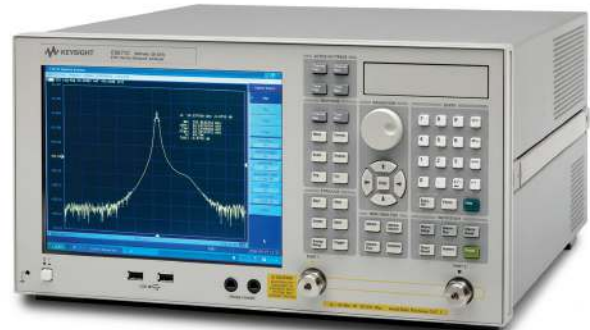

Table of Contents

Options	3
Definitions	4
Boundary Conditions	4
Corrected System Performance	5
System dynamic range	5
Corrected system performance with calibration kit	7
Uncorrected System Performance.....	13
Test Port Output (Source).....	14
Test port output frequency	14
Test port output power	15
Test port output signal purity	17
Test Port Input	18
Test port input levels	18
Test port input (compression)	20
Test port input (trace noise)	21
Test port input (stability)	23
Test port input (dynamic accuracy)	24
Test port input (group delay)	26
General Information	28
System bandwidths	28
Front panel information	28
Rear panel information	29
LXI compliance	31
EMC, safety and environment	32
Analyzer environmental specifications and dimensions	33
Measurement Throughput Summary	37
Cycle time for measurement completion (ms)	37
Cycle time (ms) vs. number of points	42
Cycle time (ms) vs. IF bandwidth	43
Cycle Time (ms) vs RF Range Fixed Mode	44
Data transfer time (ms)	45
E5092A Configurable Multiport Test Set	46
Test set input/output performance	46
Option E5092A-020 port performance	46
Control line	48
DC source	48
Operating storage environment	48
Non-operating storage environment	48
Front panel information	49
Rear panel information	49
Test set dimensions and block diagram	49
Corrected System Performance for 75 Ω Measurements with 11852B 50 to 75 Ω Minimum-Loss Pads	53

Options

This document provides technical specifications for the E5071C ENA network analyzer and the E5092A multiport test set.

E5071C-230	2-port test set, 9 kHz to 3 GHz without bias tees (Discontinued)
E5071C-235	2-port test set, 100 kHz to 3 GHz with bias tees (Discontinued)
E5071C-240	2-port test set, 9 kHz to 4.5 GHz without bias tees
E5071C-245	2-port test set, 100 kHz to 4.5 GHz with bias tees
E5071C-260	2-port test set, 9 kHz to 6.5 GHz without bias tees
E5071C-265	2-port test set, 100 kHz to 6.5 GHz with bias tees
E5071C-280	2-port test set, 9 kHz to 8.5 GHz without bias tees
E5071C-285	2-port test set, 100 kHz to 8.5 GHz with bias tees
E5071C-430	4-port test set, 9 kHz to 3 GHz without bias tees (Discontinued)
E5071C-435	4-port test set, 100 kHz to 3 GHz with bias tees (Discontinued)
E5071C-440	4-port test set, 9 kHz to 4.5 GHz without bias tees
E5071C-445	4-port test set, 100 kHz to 4.5 GHz with bias tees
E5071C-460	4-port test set, 9 kHz to 6.5 GHz without bias tees
E5071C-465	4-port test set, 100 kHz to 6.5 GHz with bias tees
E5071C-480	4-port test set, 9 kHz to 8.5 GHz without bias tees
E5071C-485	4-port test set, 100 kHz to 8.5 GHz with bias tees
E5071C-2D5	2-port test set, 300 kHz to 14 GHz with bias tees
E5071C-4D5	4-port test set, 300 kHz to 14 GHz with bias tees
E5071C-2K5	2-port test set, 300 kHz to 20 GHz with bias tees
E5071C-4K5	4-port test set, 300 kHz to 20 GHz with bias tees
E5092A	Configurable multiport test set

Calibration kits and ECal modules

This E5071C data sheet also provides technical specifications for the following calibration kits and ECal modules. For models not listed in this data sheet, please download the free Uncertainty Calculator from www.keysight.com/find/na_calculator to generate the curves for your calibration kit.

85032F	Calibration kit
85033E	Calibration kit
85052D	Calibration kit
85092C	Electronic calibration (ECal) module
85093C	Electronic calibration (ECal) module
N4691B	Electronic calibration (ECal) module

Definitions

Specification (spec.):

Warranted performance. All specifications apply at 23 °C (± 5 °C), unless otherwise stated, and 90 minutes after the instrument has been turned on. Specifications include guard bands to account for the expected statistical performance distribution, measurement uncertainties, and changes in performance due to environmental conditions.

Supplemental information is intended to provide information that is helpful for using the instrument but that is not guaranteed by the product warranty.

Typical (typ.):

Describes performance that will be met by a minimum of 80% of all products. It is not guaranteed by the product warranty.

Supplemental performance data (SPD):

Supplemental performance data represents the value of a parameter that is most likely to occur; the expected mean or average. It is not guaranteed by the product warranty.

General characteristics:

A general, descriptive term that does not imply a level of performance.

Note: The specifications in this data sheet also apply to the E5071CEP ENA network analyzer express configuration. For more information about the Express ENA, visit www.keysight.com/find/express-e5071c

Boundary Conditions

In this data sheet, boundary conditions are given for the specifications. For example, system dynamic range is 98 dB with the following boundary conditions.

Option: 485
Frequency: 10 MHz
IF bandwidth: 3 kHz

If the same boundary conditions fall under more than one category in a table, apply the best value.

Corrected System Performance

The specifications in this section apply to measurements made with the Keysight Technologies, Inc. E5071C network analyzer under the following conditions:

- No averaging applied to data
- Environmental temperature of 23 °C (± 5 °C) with less than 1 °C deviation from the calibration temperature
- Response and isolation calibration performed
- RF Range Fixed Mode: OFF

System dynamic range

Table 1. Option 230/235/240/245/260/265/280/285/430/435/440/445/460/465/480/485

Description	Specification	SPD	
System dynamic range^{1, 2, 3}			
9 kHz to 300 kHz	IF bandwidth = 3 kHz	72 dB	
300 kHz to 10 MHz		82 dB	
10 MHz to 6 GHz		98 dB	
6 GHz to 8.5 GHz		92 dB	
9 kHz to 300 kHz	IF bandwidth = 10 Hz	97 dB	115 dB
300 kHz to 10 MHz		107 dB	115 dB
10 MHz to 6 GHz		123 dB	130 dB
6 GHz to 7 GHz		117 dB	128 dB
7 GHz to 8 GHz		117 dB	126 dB
8 GHz to 8.5 GHz		117 dB	124 dB

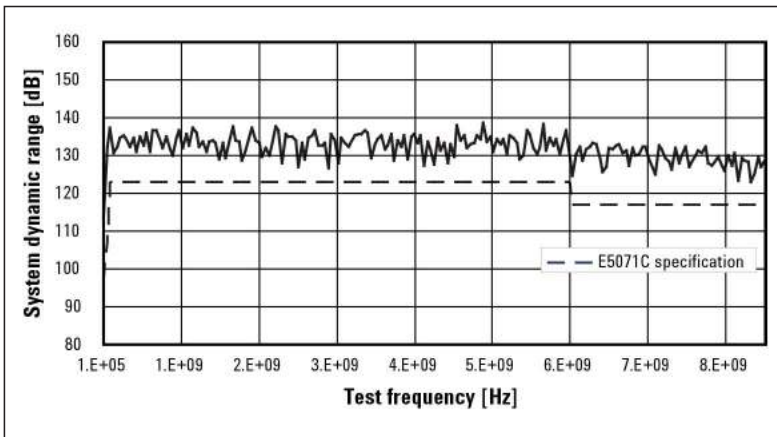

Figure 1. System dynamic range (specification and actual measurement data example, IF bandwidth 10 Hz)

1. The test port dynamic range is calculated as the difference between the test port rms noise floor and the source maximum output power. The effective dynamic range must take measurement uncertainty and interfering signals into account.
2. The specification might not be met at 5 MHz or 50 MHz.
3. System Dynamic Range may be degraded by 10 dB when RF Range Fixed Mode is ON.

System dynamic range (continued)

Table 2. Option 2D5/2K5/4D5/4K5

Description	Specification	SPD	
System dynamic range^{1, 2}			
300 kHz to 1 MHz	IF bandwidth = 3 kHz	70 dB	
1 MHz to 10 MHz		82 dB	
10 MHz to 100 MHz		95 dB	
100 MHz to 6 GHz		98 dB	
6 GHz to 8.5 GHz		92 dB	
8.5 GHz to 10.5 GHz		80 dB	
10.5 GHz to 15 GHz		75 dB	
15 GHz to 20 GHz		71 dB	
300 kHz to 1 MHz	IF bandwidth = 10 Hz	95 dB	105 dB
1 MHz to 10 MHz		107 dB	115 dB
10 MHz to 100 MHz		120 dB	129 dB
100 MHz to 6 GHz		123 dB	130 dB
6 GHz to 8 GHz		117 dB	129 dB
8 GHz to 8.5 GHz		117 dB	127 dB
8.5 GHz to 10.5 GHz		105 dB	115 dB
10.5 GHz to 15 GHz		100 dB	111 dB
15 GHz to 20 GHz	96 dB	105 dB	

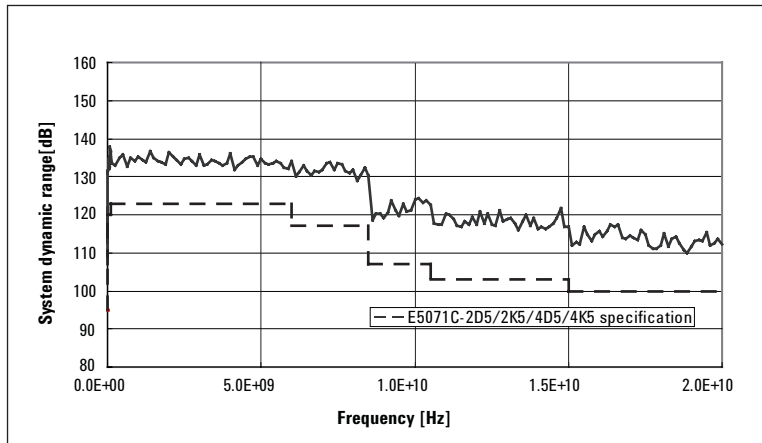

Figure 2. System dynamic range (specification and actual measurement data example, IF bandwidth 10 Hz)

1. The test port dynamic range is calculated as the difference between the test port's rms noise floor and the source's maximum output power. Effective dynamic range must take measurement uncertainty and interfering signals into account.
2. The specification might not be met at 5 MHz or 50 MHz.

Corrected system performance with calibration kit

Option 230/235/240/245/260/265/280/285/430/435/440/445/460/465/480/485

Table 3. Corrected system performance with type-N device connectors, 85032F calibration kit

Network analyzer: E5071C
 Calibration kit: 85032F (Type-N, 50 Ω)
 Calibration: full 2-port

IF bandwidth = 10 Hz, no averaging applied to data, environmental temperature = 23 $^{\circ}\text{C}$ (± 5 $^{\circ}\text{C}$) with < 1 $^{\circ}\text{C}$ deviation from calibration temperature, isolation calibration performed

Description	Specification (dB)				
	9 kHz to 300 kHz	300 kHz to 10 MHz	10 MHz to 3 GHz	3 GHz to 6 GHz	6 GHz to 8.5 GHz
Directivity	49	49	46	40	38
Source match	41	41	40	36	35
Load match	49	49	46	40	37
Reflection tracking	± 0.011	± 0.011	± 0.021	± 0.032	± 0.054
Transmission tracking	± 0.027	± 0.015	± 0.018	± 0.056	± 0.088

Transmission uncertainty (specification)

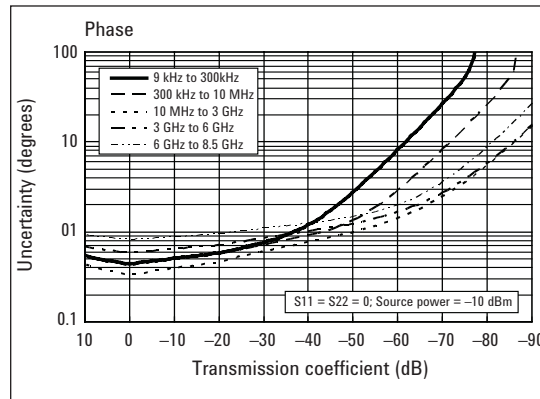
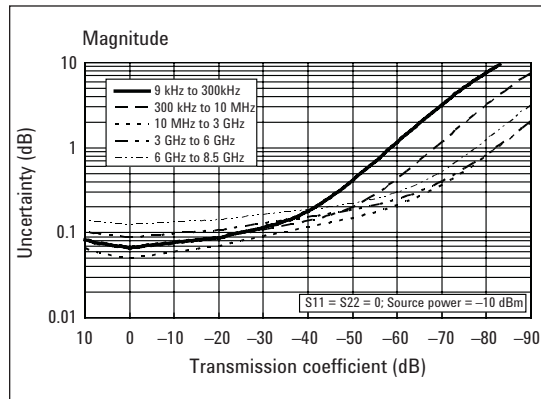

Reflection uncertainty (specification)

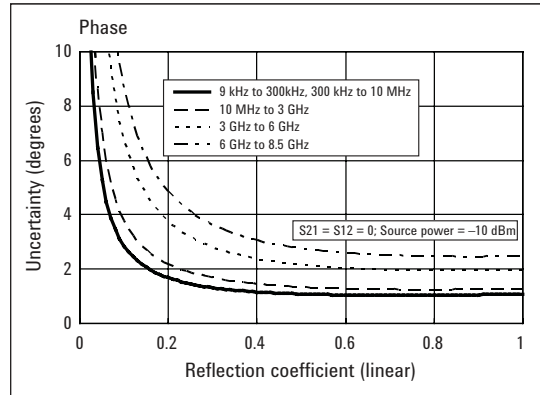
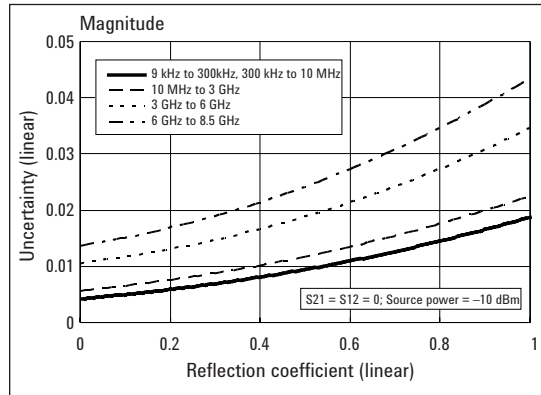

Table 4. Corrected system performance with type-N device connectors, 85092C electronic calibration (ECal) module

Network analyzer: E5071C
 Calibration module: 85092C (Type-N, 50 Ω) Electronic calibration (ECal) module
 Calibration: full 2-port

IF bandwidth = 10 Hz, no averaging applied to data, environmental temperature = 23 °C (±5 °C) with < 1 °C deviation from calibration temperature, isolation calibration is not performed

Description	Specification (dB)			
	300 kHz to 10 MHz	10 MHz to 3 GHz	3 GHz to 6 GHz	6 GHz to 8.5 GHz
Directivity	45	54	52	47
Source match	36	44	41	36
Load match	41	47	44	39
Reflection tracking	±0.100	±0.040	±0.060	±0.070
Transmission tracking	±0.055	±0.039	±0.068	±0.136

Transmission uncertainty (specification)

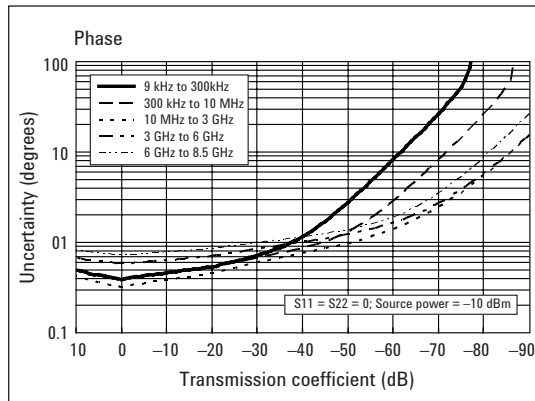
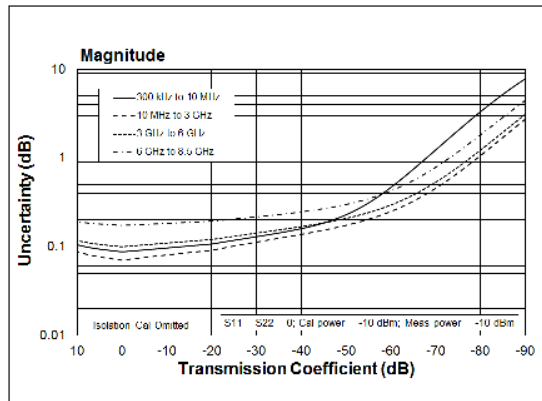

Reflection uncertainty (specification)

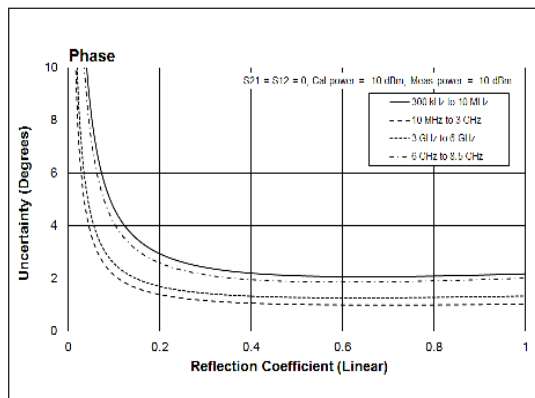
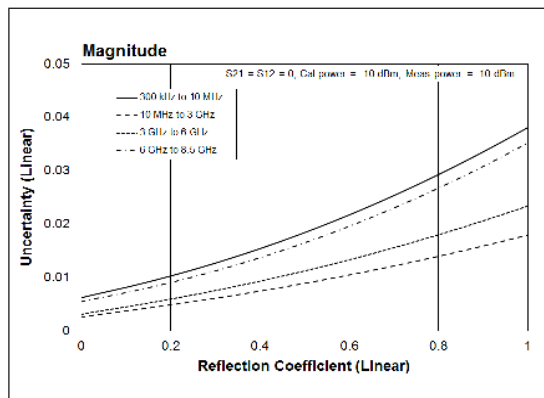

Table 5. Corrected system performance with 3.5 mm device connector type, 85033E calibration kit

Network analyzer: E5071C
 Calibration kit: 85033E (3.5 mm, 50 Ω)
 Calibration: full 2-port

IF bandwidth = 10 Hz, no averaging applied to data, environmental temperature = 23 °C (±5 °C) with < 1 °C deviation from calibration temperature, isolation calibration performed

Description	Specification (dB)				
	9 kHz to 300 kHz	300 kHz to 10 MHz	10 MHz to 3 GHz	3 GHz to 6 GHz	6 GHz to 8.5 GHz
Directivity	46	46	44	38	38
Source match	43	43	40	37	36
Load match	46	46	44	38	38
Reflection tracking	±0.006	±0.006	±0.007	±0.009	±0.010
Transmission tracking	±0.026	±0.015	±0.020	±0.058	±0.079

Transmission uncertainty (specification)

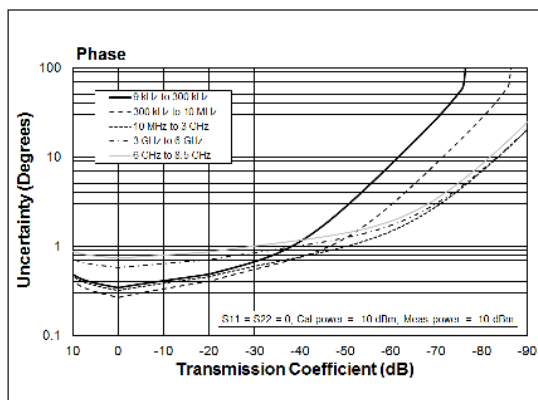
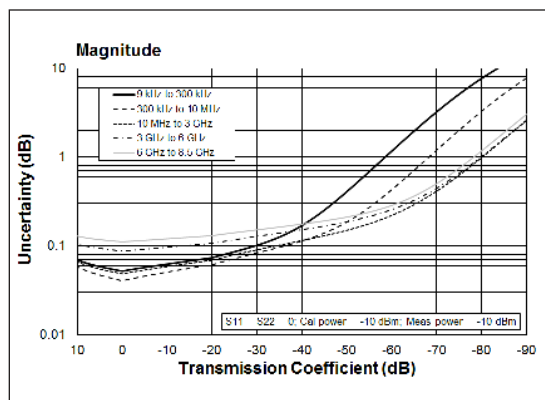

Reflection uncertainty (specification)

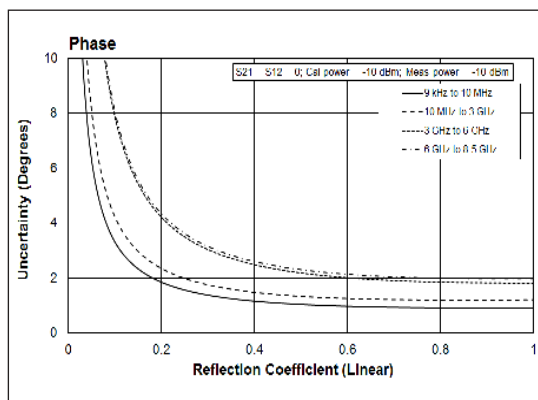
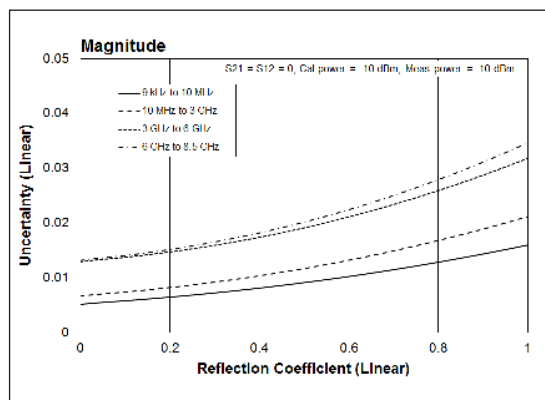

Table 6. Corrected system performance with 3.5 mm device connector type, 85093C electronic calibration (ECal) module

Network analyzer: E5071C
 Calibration module: 85093C (3.5 mm, 50 Ω) electronic calibration (ECal) module
 Calibration: full 2-port

IF bandwidth = 10 Hz, no averaging applied to data, environmental temperature = 23 °C (±5 °C) with < 1 °C deviation from calibration temperature, isolation calibration is not performed

Description	Specification (dB)			
	300 kHz to 10 MHz	10 MHz to 3 GHz	3 GHz to 6 GHz	6 GHz to 8.5 GHz
Directivity	45	52	50	47
Source match	36	44	39	34
Load match	37	45	42	40
Reflection tracking	±0.100	±0.040	±0.050	±0.070
Transmission tracking	±0.086	±0.045	±0.094	±0.143

Transmission uncertainty (specification)

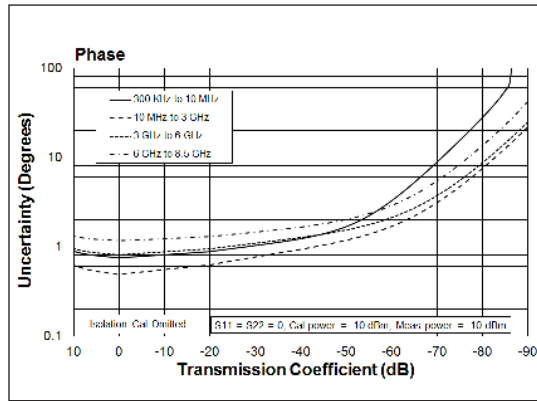
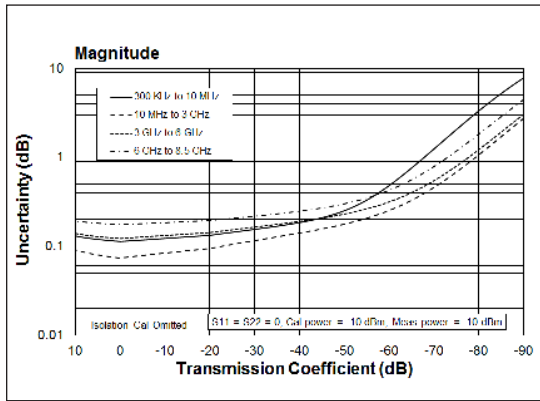

Reflection uncertainty (specification)

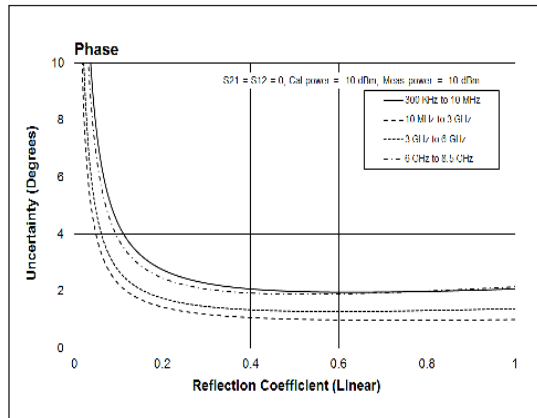
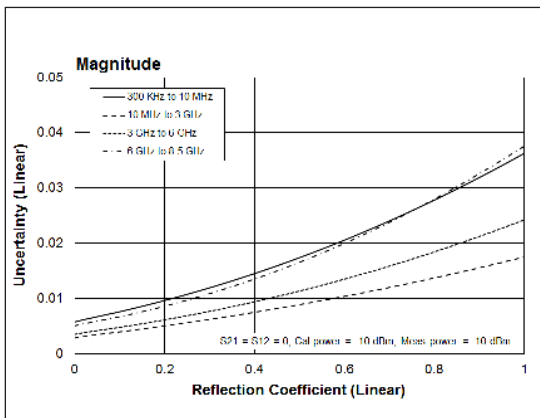

Option 2D5/2K5/4D5/4K5

Table 7. Corrected system performance with 3.5 mm device connectors, 85052D calibration kit

Network analyzer: E5071C
 Calibration kit: 85052D (3.5 mm, 50 Ω)
 Calibration: full 2-port

IF bandwidth = 10 Hz, no averaging applied to data, environmental temperature = 23 °C (±5 °C) with < 1 °C deviation from calibration temperature, isolation calibration performed

Description	Specification (dB)			
	300 kHz to 500 MHz	500 MHz to 2 GHz	2 GHz to 6 GHz	6 GHz to 20 GHz
Directivity	42	42	38	36
Source match	37	37	31	28
Load match	42	42	38	36
Reflection tracking	±0.003	±0.003	±0.004	±0.008
Transmission tracking	±0.068	±0.034	±0.100	±0.208

Transmission uncertainty (specification)

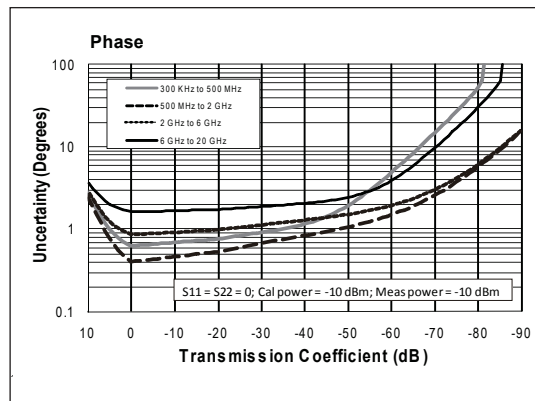
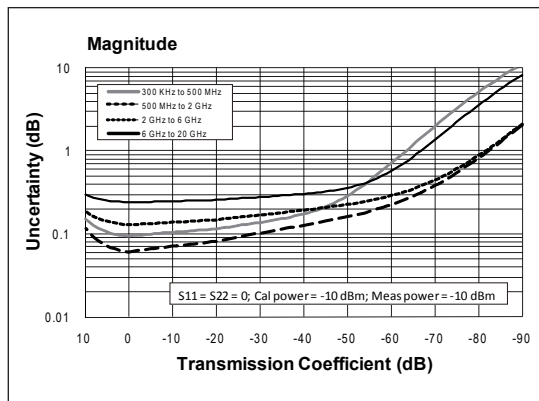

Reflection uncertainty (specification)

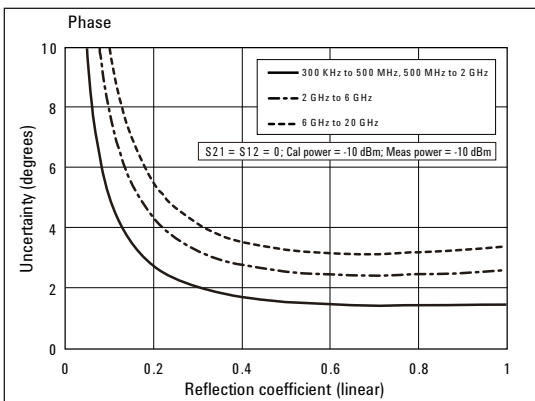
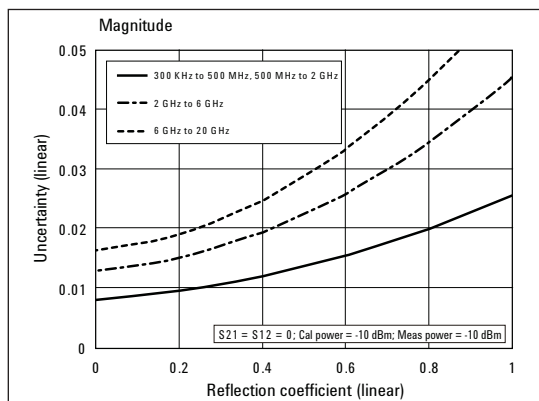

Table 8. Corrected system performance with 3.5 mm device connectors, N4691B electronic calibration (ECal) module

Network analyzer: E5071C
 Calibration module: N4691B (3.5 mm, 50 Ω) electronic calibration (ECal) module
 Calibration: full 2-port

IF bandwidth = 10 Hz, no averaging applied to data, environmental temperature = 23 °C (±5 °C) with < 1 °C deviation from calibration temperature, isolation calibration is not performed

Description	Specification (dB)			
	300 kHz to 500 MHz	500 MHz to 2 GHz	2 GHz to 6 GHz	6 GHz to 20 GHz
Directivity	31	52	48	46
Source match	29	47	45	42
Load match	27	47	43	39
Reflection tracking	±0.110	±0.020	±0.030	±0.040
Transmission tracking	±0.355	±0.026	±0.043	±0.130

Transmission uncertainty (specification)

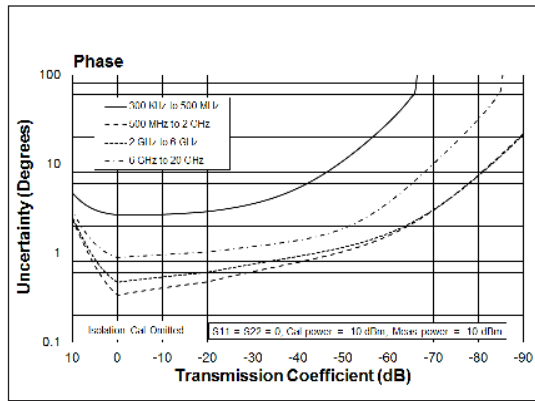
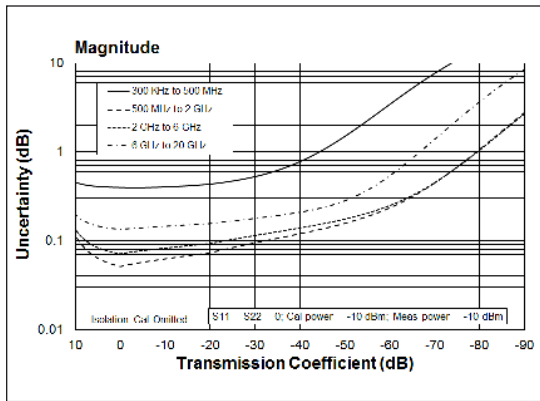

Reflection uncertainty (specification)

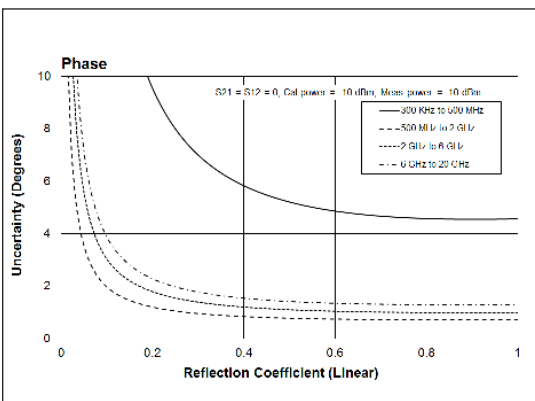
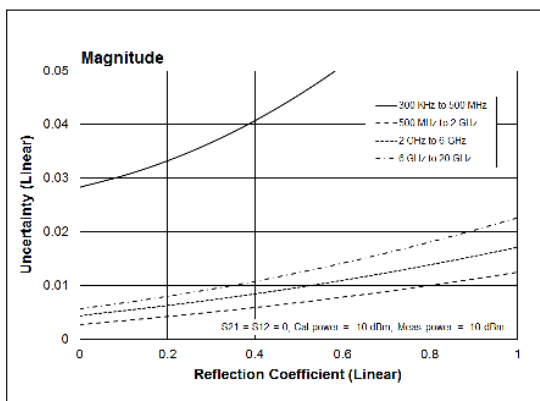

Uncorrected System Performance¹

Table 9. Option 230/235/240/245/260/265/280/285/430/435/440/445/460/465/480/485

User correction: OFF, system correction: ON

Description	Specification (dB)			
	9 kHz to 300 kHz	300 kHz to 3 GHz	3 GHz to 6 GHz	6 GHz to 8.5 GHz
Directivity	20 dB	25 dB	20 dB	15 dB
Source match	20 dB	25 dB	20 dB	15 dB
Load match ²	12 dB	17 dB	12 dB	10 dB
Transmission tracking ³	±1.5 dB	±1.0 dB	±1.0 dB	±1.0 dB
Reflection tracking	±1.5 dB	±1.0 dB	±1.0 dB	±1.0 dB

Table 10. Option 2D5/2K5/4D5/4K5

User correction: OFF, system correction: ON

Description	Specification (dB)						
	300 kHz to 1 MHz	1 MHz to 1 GHz	1 GHz to 3 GHz	3 GHz to 6 GHz	6 GHz to 8.5 GHz	8.5 GHz to 11 GHz	11 GHz to 20 GHz
Directivity	20 dB	25 dB	25 dB	20 dB	15 dB	15 dB	15 dB
Source match	20 dB	25 dB	25 dB	20 dB	15 dB	15 dB	15 dB
Load match	9 dB	17 dB	15 dB	11 dB	9 dB	8 dB	7 dB
Transmission tracking	±1.0 dB	±1.0 dB	±1.0 dB	±1.0 dB	±1.0 dB	±1.0 dB	±1.0 dB
Reflection tracking	±1.0 dB	±1.0 dB	±1.0 dB	±1.0 dB	±1.0 dB	±1.0 dB	±1.0 dB

1. The specification might not be met when Shift LO Mode is ON.

2. Load match may be degraded by 3 dB when RF Range Fixed Mode is ON.

3. Transmission tracking may be degraded by ± 4 dB when RF Range Fixed Mode is ON.

Test Port Output (Source)

Test port output frequency

Table 11. Option 230/235/240/245/260/265/280/285/430/435/440/445/460/465/480/485/2D5/2K5/4D5/4K5

Description	Specification	Typical
Frequency range		
Option 230/430	9 kHz to 3 GHz	
Option 240/440	9 kHz to 4.5 GHz	
Option 260/460	9 kHz to 6.5 GHz	
Option 280/480	9 kHz to 8.5 GHz	
Option 235/435	100 kHz to 3 GHz	
Option 245/445	100 kHz to 4.5 GHz	
Option 265/465	100 kHz to 6.5 GHz	
Option 285/485	100 kHz to 8.5 GHz	
Option 2D5/4D5	300 kHz to 14 GHz	
Option 2K5/4K5	300 kHz to 20 GHz	
Resolution	1 Hz	
Source stability		
standard		±7 ppm (5 to 40 °C)
Option 1E5		±0.05 ppm (5 to 40 °C), ±0.5 ppm/year
CW accuracy		
standard	±7 ppm	
Option 1E5	±0.45 ppm (Serial Number Prefix MY463/SG463 and above) ±1 ppm (Serial Number Prefix MY462/SG462 and below)	

Test port output power¹

Table 12. Option 230/235/240/245/260/265/280/285/430/435/440/445/460/465/480/485

Description	Specification	Typical
Nominal power (preset power)	0 dBm	
Level accuracy ^{2, 6} (stepped sweep mode)	±0.650 dB (at 0 dBm, 50 MHz absolute) ±1.0 dB	
Level accuracy ² (swept sweep mode)		±2.5 dB
Level linearity ^{3, 5, 6} (stepped sweep mode)		
9 kHz to 5 GHz	±0.75 dB (–20 to 10 dBm)	
5 GHz to 6 GHz	±0.75 dB (–20 to 9 dBm)	
6 GHz to 7 GHz	±0.75 dB (–20 to 8 dBm)	
7 GHz to 8.5 GHz	±0.75 dB (–20 to 7 dBm)	
Level linearity ⁵ (swept sweep mode) ⁴		
9 kHz to 5 GHz		±1.5 dB (at –20 to 10 dBm)
5 GHz to 6 GHz		±1.5 dB (at –20 to 9 dBm)
6 GHz to 7 GHz		±1.5 dB (at –20 to 8 dBm)
7 GHz to 8.5 GHz		±1.5 dB (at –20 to 7 dBm)
Range ^{5, 6}		
9 kHz to 5 GHz	–55 to 10 dBm	
5 GHz to 6 GHz	–55 to 9 dBm	
6 GHz to 7 GHz	–55 to 8 dBm	
7 GHz to 8.5 GHz	–55 to 7 dBm	
Sweep range ^{5, 6}		
9 kHz to 5 GHz	–55 to 10 dBm	
5 GHz to 6 GHz	–55 to 9 dBm	
6 GHz to 7 GHz	–55 to 8 dBm	
7 GHz to 8.5 GHz	–55 to 7 dBm	
Level resolution	0.05 dB	

Description	Specification	SPD
Max leveled power ^{5, 6} (Option 230/235/240/245/260/ 265/280/285)		
9 kHz to 8.5 GHz		10 dBm
(Option 430/435/440/445/460/ 465/480/485)		
9 kHz to 6 GHz		10 dBm
6 GHz to 7 GHz		9 dBm
7 GHz to 8.5 GHz		8 dBm

1. Source output performance on port 1 only. Other port output performance is typical.
2. Level accuracy is taken at 0 dBm, relative to 50 MHz reference unless otherwise stated.
3. Level linearity given is relative to 0 dBm.
4. The specification might not be met at 5 MHz or 50 MHz.
5. The level accuracy specification needs to be taken into account for test port output power level.
6. Power calibration using an external power meter improves level accuracy of the test port output power. Proper power meters/sensors, and the 82357B USB-GPIB interface are required to conduct power calibration.

Test port output power⁷ (continued)

Table 13. Option 2D5/2K5/4D5/4K5

Description	Specification	Typical
Nominal power (preset power)	-5 dBm	
Level accuracy ⁶ (stepped sweep mode) ¹	±0.650 dB (at -5 dBm, 50 MHz absolute)	
300 kHz to 1 MHz	+2.0 dB, -6.0 dB	
1 MHz to 5 MHz	±2.0 dB	
5 MHz to 8.5 GHz	±1.0 dB	
8.5 GHz to 20 GHz	±2.5 dB	
Level accuracy (swept sweep mode) ²		
300 kHz to 1 GHz		±5.0 dB
1 GHz to 8.5 GHz		±2.5 dB
8.5 GHz to 20 GHz		+5.0 dB, -7.0 dB
Level linearity ^{5, 6} (stepped sweep mode) ³		
300 kHz to 1 MHz	±0.75 dB (-25 to 8 dBm)	
1 MHz to 6 GHz	±0.75 dB (-25 to 10 dBm)	
6 GHz to 8 GHz	±0.75 dB (-25 to 9 dBm)	
8 GHz to 10.5 GHz	±0.75 dB (-25 to 7 dBm)	
10.5 GHz to 15 GHz	±0.75 dB (-25 to 3 dBm)	
15 GHz to 20 GHz	±0.75 dB (-25 to 0 dBm)	
Level linearity ⁵ (swept sweep mode) ³		
300 kHz to 1 MHz		±1.5 dB (-25 to 8 dBm)
1 MHz to 6 GHz		±1.5 dB (-25 to 10 dBm)
6 GHz to 8 GHz		±1.5 dB (-25 to 9 dBm)
8 GHz to 10.5 GHz		±1.5 dB (-25 to 7 dBm)
10.5 GHz to 15 GHz		±1.5 dB (-25 to 3 dBm)
15 GHz to 20 GHz		±1.5 dB (-25 to 0 dBm)
Range ^{5, 6}		
300 kHz to 1 MHz	-85 to 8 dBm	
1 MHz to 6 GHz	-85 to 10 dBm	
6 GHz to 8 GHz	-85 to 9 dBm	
8 GHz to 10.5 GHz	-85 to 7 dBm	
10.5 GHz to 15 GHz	-85 to 3 dBm	
15 GHz to 20 GHz	-85 to 0 dBm	
Sweep range ^{4, 5, 6}		
300 kHz to 1 MHz	-25 to 8 dBm	
1 MHz to 6 GHz	-25 to 10 dBm	
6 GHz to 8 GHz	-25 to 9 dBm	
8 GHz to 10.5 GHz	-25 to 7 dBm	
10.5 GHz to 15 GHz	-25 to 3 dBm	
15 GHz to 20 GHz	-25 to 0 dBm	
(Source attenuator = 0 dB)		
Level resolution	0.05 dB	

1. Level accuracy is taken at -5 dBm, relative to 50 MHz reference unless otherwise stated.
2. Level accuracy is taken at -5 dBm, relative to 50 MHz reference.
3. Level linearity given is relative to -5 dBm.
4. The sweep range shifts based on the selected source attenuator value (0 dB to 60 dB, 10 dB step).
5. The level accuracy specification needs to be taken into account for test port output power level.
6. Power calibration using an external power meter improves level accuracy of the test port output power. Proper power meters/sensors, and the 82357B USB-GPIB interface are required to conduct power calibration.
7. Source output performance on port 1 only. Other port output performance is typical.

Test port output power⁶ (continued)

Table 13. Option 2D5/2K5/4D5/4K5

Description	Specification	SPD
Max leveled power ^{3, 4}		
300 kHz to 1 MHz		9 dBm
1 MHz to 10 GHz		10 dBm
10 GHz to 13 GHz		9 dBm
13 GHz to 15 GHz		7 dBm
15 GHz to 18 GHz		5 dBm
18 GHz to 20 GHz		4 dBm

Test port output signal purity

Table 14. Option 230/235/240/245/260/265/280/285/430/435/440/445/460/465/480/485

Description	Specification	Typical
Harmonics (2nd or 3rd)		
9 kHz to 2 GHz		< -25 dBc (at 5 dBm)
2 GHz to 8.5 GHz		< -20 dBc (at 5 dBm)
Non-harmonic spurious		
9 kHz to 8.5 GHz		< -30 dBc (at 5 dBm)

Table 15. Option 2D5/2K5/4D5/4K5

Description	Specification	Typical
Harmonics (2nd to 5th) ¹		
300 kHz to 1 GHz		< -12 dBc (at maximum output power) ⁵
1 GHz to 20 GHz		< -15 dBc (at maximum output power) ⁵
Non-harmonic spurious ²		
300 kHz to 20 GHz		< -30 dBc (at -5 dBm)

1. This includes 6th and 7th harmonics when the test frequency is from 1 MHz to 1 GHz.
2. The carrier $\pm 1/8$ th spurious is excluded from 8.76 GHz to 17.52 GHz.
3. The level accuracy specification needs to be taken into account for test port output power level.
4. Power calibration using an external power meter improves level accuracy of the test port output power. Proper power meters/sensors, and the 82357B USB-GPIB interface are required to conduct power calibration.
5. Maximum output power is the maximum power of "Range" in Table 13 Test port output power.
6. Source output performance on port 1 only. Other port output performance is typical.

Test Port Input

Test port input levels

Table 16. Option 230/235/240/245/260/265/280/285/430/435/440/445/460/465/480/485

Description	Specification	Typical
Maximum test port input level		
9 kHz to 8.5 GHz	+10 dBm	
Damage level		
9 kHz to 8.5 GHz		+26 dBm ±35 VDC
Crosstalk ^{1, 2}		
9 kHz to 300 kHz	-100 dB	
300 kHz to 10 MHz	-110 dB	
10 MHz to 3 GHz	-120 dB	
3 GHz to 6 GHz	-110 dB	
6 GHz to 8.5 GHz	-100 dB	

Description	Specification	SPD
Test port noise floor ³		
9 kHz to 300 kHz	-97 dBm/Hz	-115 dBm/Hz
300 kHz to 10 MHz	-107 dBm/Hz	-115 dBm/Hz
10 MHz to 5 GHz	-123 dBm/Hz	-130 dBm/Hz
5 GHz to 6 GHz	-124 dBm/Hz	-131 dBm/Hz
6 GHz to 7 GHz	-119 dBm/Hz	-130 dBm/Hz
7 GHz to 8 GHz	-120 dBm/Hz	-129 dBm/Hz
8 GHz to 8.5 GHz	-120 dBm/Hz	-127 dBm/Hz

1. The specification might not be met at 5 MHz or 50 MHz.

2. Cross talk may be degraded by 10 dB when RF Range Fixed Mode is ON .

3. Test port noise floor may be degraded by 10 dB when RF Range Fixed Mode is ON.

Test port input levels (continued)

Table 17. Option 2D5/2K5/4D5/4K5

Description	Specification	Typical
Maximum test port input level		
300 kHz to 20 GHz	+10 dBm	
Damage level		
300 kHz to 20 GHz		+26 dBm or ± 35 VDC
Crosstalk ¹		
300 kHz to 1 MHz	-68 dB	
1 MHz to 5 MHz	-70 dB	
5 MHz to 10 MHz	-100 dB	
10 MHz to 45 MHz	-110 dB	
45 MHz to 4 GHz	-118 dB	
4 GHz to 6 GHz	-123 dB	
6 GHz to 8.5 GHz	-120 dB	
8.5 GHz to 15 GHz	-112 dB	
15 GHz to 20 GHz	-106 dB	
Description	Specification	SPD
Test port noise floor		
300 kHz to 1 MHz	-97 dBm/Hz	-110 dBm/Hz
1 MHz to 10 MHz	-107 dBm/Hz	-115 dBm/Hz
10 MHz to 100 MHz	-120 dBm/Hz	-129 dBm/Hz
100 MHz to 6 GHz	-123 dBm/Hz	-130 dBm/Hz
6 GHz to 8 GHz	-118 dBm/Hz	-130 dBm/Hz
8 GHz to 8.5 GHz	-120 dBm/Hz	-130 dBm/Hz
8.5 GHz to 10.5 GHz	-108 dBm/Hz	-120 dBm/Hz
10.5 GHz to 15 GHz	-107 dBm/Hz	-120 dBm/Hz
15 GHz to 20 GHz	-106 dBm/Hz	-119 dBm/Hz

1. The specification might not be met at 5 MHz or 50 MHz.

Test port input (compression level)

Table 18. Option 230/235/240/245/260/265/280/285/430/435/440/445/460/465/480/485

Description	Specification	SPD
Compression level		
Magnitude		
9 kHz to 5 GHz		0.08 dB
5 GHz to 8.5 GHz		0.1 dB
(maximum test port input level = +10 dBm)		
Phase		
9 kHz to 3 GHz		0.3 deg
3 GHz to 5 GHz		0.6 deg
5 GHz to 8.5 GHz		1.0 deg
(maximum test port input level = +10 dBm)		

Table 19. Option 2D5/2K5/4D5/4K5

Description	Specification	SPD
Compression level		
Magnitude		
300 kHz to 10 MHz		0.3 dB
10 MHz to 10 GHz		0.182 dB
10 GHz to 15 GHz		0.712 dB
15 GHz to 20 GHz		1.87 dB
(maximum test port input level = +10 dBm)		
Phase		
300 kHz to 5 GHz		2.3 deg
5 GHz to 10 GHz		4.3 deg
10 GHz to 15 GHz		17.3 deg
15 GHz to 20 GHz		20.3 deg
(maximum test port input level = +10 dBm)		

Test port input (trace noise)

Table 20. Option 230/235/240/245/260/265/280/285/430/435/440/445/460/465/480/485

Description	Specification ³	SPD
Trace noise magnitude ¹		
9 kHz to 30 kHz (IFBW = 3 kHz)	0.004 dB rms	0.001 dB rms
30 kHz to 100 kHz (IFBW = 3 kHz)	0.003 dB rms	0.001 dB rms
100 kHz to 10 MHz (IFBW = 3 kHz)	0.003 dB rms	0.0005 dB rms
10 MHz to 4.38 GHz (IFBW = 10 kHz)		0.0005 dB rms
4.38 GHz to 8.5 GHz (IFBW = 10 kHz)		0.0006 dB rms
10 MHz to 4.38 GHz (IFBW = 70 kHz)	0.004 dB rms (Reflection)	0.001 dB rms
	0.003 dB rms (Transmission)	
4.38 GHz to 5 GHz (IFBW = 70 kHz)	0.006 dB rms	0.0012 dB rms
5 GHz to 6 GHz (IFBW = 70 kHz)	0.006 dB rms	0.0012 dB rms
6 GHz to 7 GHz (IFBW = 70 kHz)	0.006 dB rms	0.0012 dB rms
7 GHz to 8.5 GHz (IFBW = 70 kHz) (at maximum output power level of sweep range)	0.006 dB rms	0.0012 dB rms
Trace noise phase ²		
9 kHz to 30 kHz (IFBW = 3 kHz)	0.035 deg rms	
30 kHz to 10 MHz (IFBW = 3 kHz)	0.020 deg rms	
10 MHz to 4.38 GHz (IFBW = 70 kHz)	0.035 deg rms	
4.38 GHz to 5 GHz (IFBW = 70 kHz)	0.050 deg rms	
5 GHz to 6 GHz (IFBW = 70 kHz)	0.050 deg rms	
6 GHz to 7 GHz (IFBW = 70 kHz)	0.050 deg rms	
7 GHz to 8.5 GHz (IFBW = 70 kHz) (at maximum output power level of sweep range)	0.050 deg rms	

1. The specification might not be met at the following frequencies: 333.333 kHz, 406.25 kHz, 857.143 kHz, 928.571 kHz, 1.3 MHz, 2.4 MHz and 4.333333 MHz.

2. The specification might not be met at 5 MHz or 50 MHz.

3. When RF Range Fixed Mode is ON, multiply by 2.3.

Test port input (trace noise) (continued)

Table 21. Option 2D5/2K5/4D5/4K5

Description	Specification	SPD
Trace noise magnitude^{1, 3}		
300 kHz to 1 MHz (IFBW = 3 kHz)	0.006 dB rms	0.0009 dB rms
1 MHz to 10 MHz (IFBW = 3 kHz)	0.003 dB rms	0.0005 dB rms
10 MHz to 4.38 GHz (IFBW = 70 kHz)	0.004 dB rms	0.0010 dB rms
4.38 GHz to 8.5 GHz (IFBW = 70 kHz)	0.006 dB rms	0.0012 dB rms
8.5 GHz to 13.137 GHz (IFBW = 70 kHz)	0.009 dB rms	0.0024 dB rms
13.137 GHz to 17 GHz (IFBW = 70 kHz)	0.013 dB rms	0.0040 dB rms
17 GHz to 20 GHz (IFBW = 70 kHz) (at maximum output power level of sweep range)	0.023 dB rms	0.0065 dB rms
Trace noise phase^{2, 3}		
300 kHz to 1 MHz (IFBW = 3 kHz)	0.040 deg rms	0.0120 deg rms
1 MHz to 10 MHz (IFBW = 3 kHz)	0.020 deg rms	0.0025 deg rms
10 MHz to 4.38 GHz (IFBW = 70 kHz)	0.035 deg rms	0.0075 deg rms
4.38 GHz to 8.5 GHz (IFBW = 70 kHz)	0.050 deg rms	0.0150 deg rms
8.5 GHz to 13.137 GHz (IFBW = 70 kHz)	0.064 deg rms	0.0250 deg rms
13.137 GHz to 17 GHz (IFBW = 70 kHz)	0.095 deg rms	0.0320 deg rms
17 GHz to 20 GHz (IFBW = 70 kHz) (at maximum output power level of sweep range)	0.165 deg rms	0.0520 deg rms

1. The specification might not be met at the following frequencies: 406.25 kHz, 666.667 kHz, 722.222 kHz, 857.143 kHz, 928.571 kHz, 1.444444 MHz, 1.714286 MHz, 1.8 MHz, 1.857143 MHz, 1.95 MHz, 2.4375 MHz, 2.571429 MHz, 3.714286 MHz, 4.8 MHz, 5 MHz, 5.416667 MHz, 7.583333 MHz, 10 MHz, 10.833333 MHz, 12.5 MHz.

2. The specification might not be met at 5 MHz or 50 MHz.

3. Trace noise SPD is defined with transmission measurements only.

Test port input (stability)¹

Table 22. Option 230/235/240/245/260/265/280/285/430/435/440/445/460/465/480/485

Description	Specification	SPD
Stability magnitude		
9 kHz to 3 GHz		±0.005 dB/°C
3 GHz to 6 GHz		±0.01 dB/°C
6 GHz to 8.5 GHz		±0.04 dB/°C
Stability phase		
9 kHz to 3 GHz		±0.1 deg/°C
3 GHz to 6 GHz		±0.2 deg/°C
6 GHz to 8.5 GHz		±0.8 deg/°C

Table 23. Option 2D5/2K5/4D5/4K5

Description	Specification	SPD
Stability magnitude		
300 kHz to 3 GHz		±0.005 dB/°C
3 GHz to 6 GHz		±0.01 dB/°C
6 GHz to 20 GHz		±0.04 dB/°C
Stability phase		
300 kHz to 3 GHz		±0.1 deg/°C
3 GHz to 6 GHz		±0.2 deg/°C
6 GHz to 20 GHz		±0.8 deg/°C

1. Stability is defined as a ratio measurement at the test port.

Test port input (dynamic accuracy)^{1, 2}

Table 24. Option 230/235/240/245/260/265/280/285/430/435/440/445/460/465/480/485

Accuracy of the test port input power reading is relative to -10 dBm reference input power level.

Description	Specification	Typical
Dynamic accuracy magnitude		
10 dBm	± 0.207 dB	
-30 dBm	± 0.045 dB	
-100 dBm	± 2.00 dB	
-110 dBm		± 3.0 dB
Dynamic accuracy phase		
10 dBm	± 5.03 deg	
-30 dBm	± 0.30 deg	
-100 dBm	± 15.0 deg	

Specification

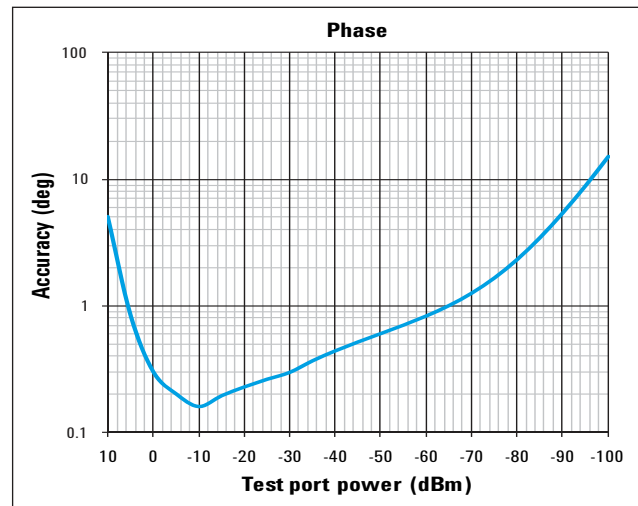
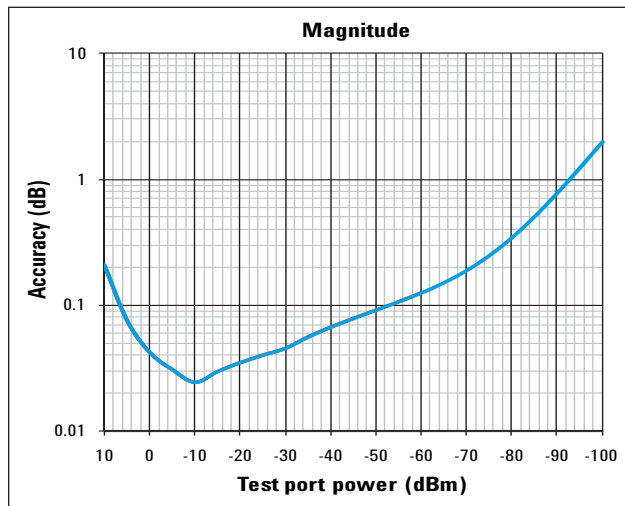

± 3.0 dB (at -110 dBm, Ref. = -10 dBm, typical)

- Dynamic accuracy is verified with the following measurements:
 - compression over frequency
 - IF linearity at two frequencies (1 MHz and 1.195 GHz) using a reference level of -10 dBm for an input power range of 0 to -100 dBm. For value below -60 dBm, refer to "VNA Receiver Dynamic Accuracy Specifications and Uncertainties N5247-90003" <http://cp.literature.keysight.com/litweb/pdf/N5247-90003.pdf>
- RF Range Fixed Mode is OFF

Test port input (dynamic accuracy)¹ (continued)

Table 25. Option 2D5/2K5/4D5/4K5

Accuracy of the test port input power reading is relative to -10 dBm reference input power level.

Description	Specification	Typical
Dynamic accuracy magnitude		
10 dBm	± 2.49 dB	
-30 dBm	± 0.046 dB	
-100 dBm	± 2.00 dB	
-110 dBm		± 3.0 dB
Dynamic accuracy phase		
10 dBm	± 20.6 deg	
-30 dBm	± 0.30 deg	
-100 dBm	± 15.0 deg	

Specification

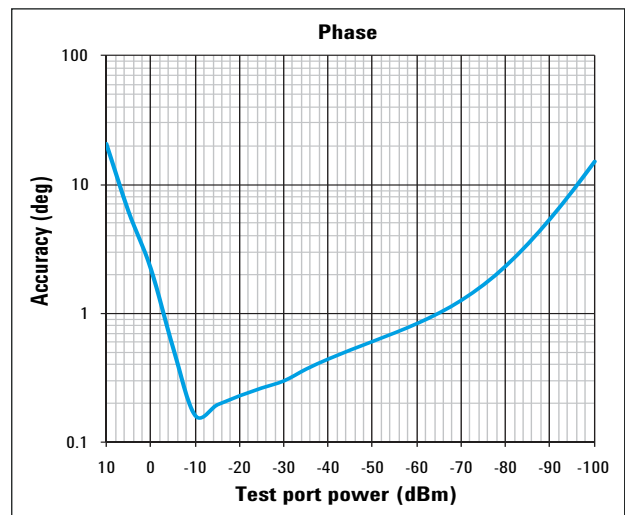
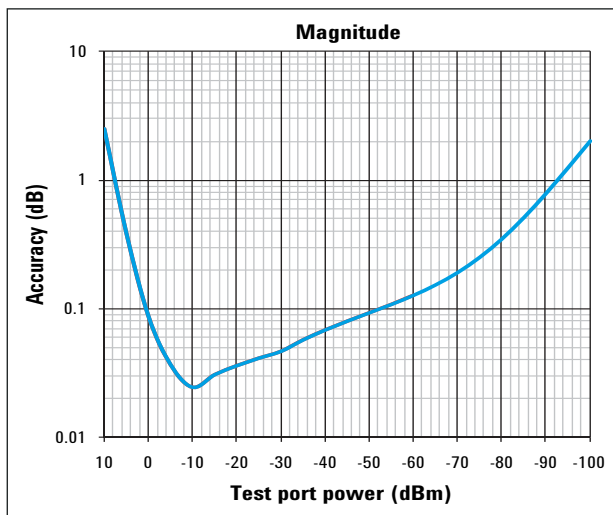

± 3.0 dB (at -110 dBm, Ref. = -10 dBm, typical)

- Dynamic accuracy is verified with the following measurements:
 - compression over frequency
 - IF linearity at two frequencies (1 MHz and 1.195 GHz) using a reference level of -10 dBm for an input power range of 0 to -60 dBm. For value below -60 dBm, refer to "VNA Receiver Dynamic Accuracy Specifications and Uncertainties N5247-90003" <http://cp.literature.keysight.com/litweb/pdf/N5247-90003.pdf>.

Test port input (group delay)¹

Table 26. Option 230/235/240/245/260/265/280/285/430/435/440/445/460/465/480/485

Description	Specification	Supplemental information
Aperture (selectable)	(frequency span)/(number of points - 1)	
Maximum aperture	25% of frequency span	
Minimum delay		Limited to measuring no more than 180° of phase change within the minimum aperture.
Accuracy		See graph below, typical

The following graph shows group delay accuracy with type-N connectors, full 2-port calibration and a 10 Hz IF bandwidth, RF Range Fixed Mode: OFF

Calibration kit (85032F). Insertion loss is assumed to be < 2 dB.

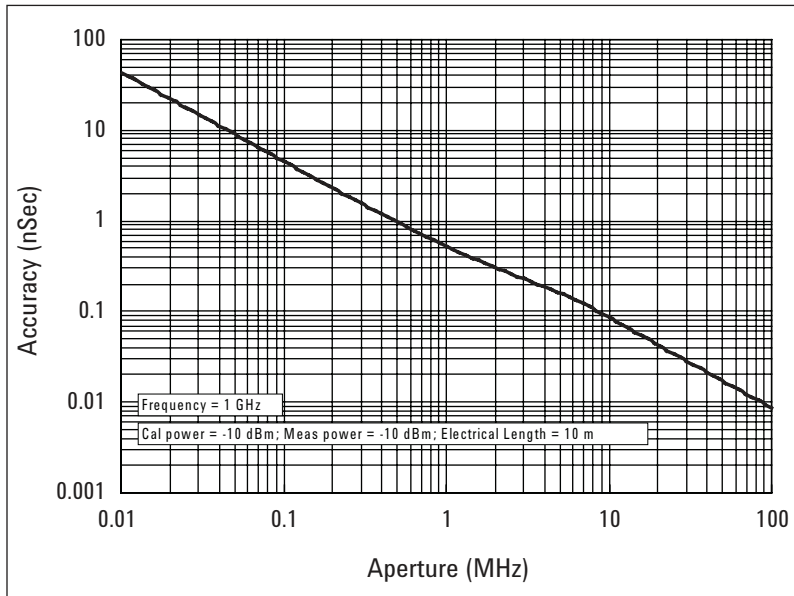

In general, the following formula can be used to determine the accuracy, in seconds, of a specific group delay measurement:

$$\pm \text{phase accuracy (degrees)} / [360 \times \text{aperture (Hz)}]$$

1. Group delay is computed by measuring the phase change within a specified step (determined by the frequency span and the number of points per sweep).

Test port input (group delay)¹ (continued)

Table 27. Option 2D5/2K5/4D5/4K5

Description	Specification	Supplemental information
Aperture (selectable)	(frequency span)/(number of points - 1)	
Maximum aperture	25% of frequency span	
Minimum delay		Limited to measuring no more than 180° of phase change within the minimum aperture.
Accuracy		See graph below, typical

The following graph shows group delay accuracy with 3.5 mm (male) connectors, full 2-port calibration and a 10 Hz IF bandwidth.

Calibration kit (85052D). Insertion loss is assumed to be < 2 dB.

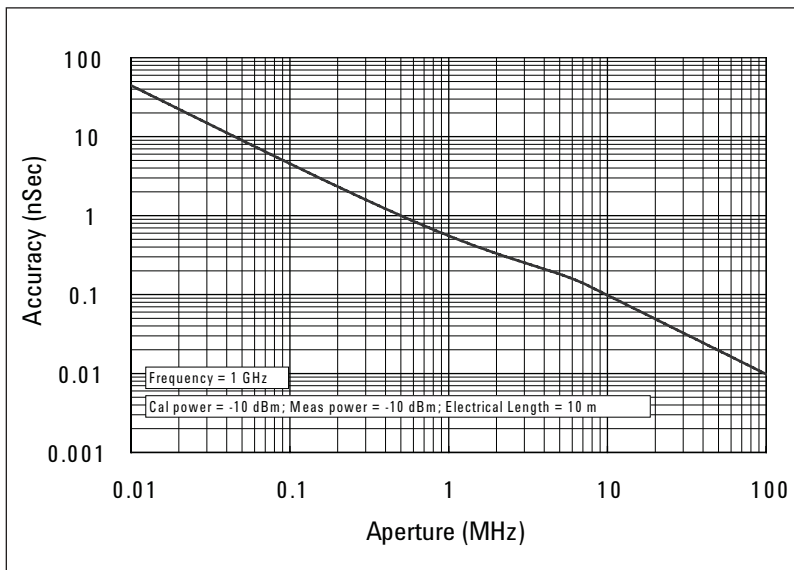

In general, the following formula can be used to determine the accuracy, in seconds, of a specific group delay measurement:

$$\pm \text{phase accuracy (degrees)} / [360 \times \text{aperture (Hz)}]$$

1. Group delay is computed by measuring the phase change within a specified step (determined by the frequency span and the number of points per sweep).

General Information

Table 28. System bandwidth

Description	General characteristics
IF bandwidth settings	
Range	10 Hz to 1.5 MHz Nominal settings are: 10, 15, 20, 30, 40, 50, 70, 100, 150, 200, 300, 400, 500, 700, 1 k, 1.5 k, 2 k, 3 k, 4 k, 5 k, 7 k, 10 k, 15 k, 20 k, 30 k, 40 k, 50 k, 70 k, 100 k, 150 k, 200 k, 300 k, 400 k, 500 kHz, 700 kHz, 1 MHz, 1.5 MHz

Table 29. Front panel information

Description	Typical	General characteristics
RF connectors		
Option 230/235/240/ 245/260/265/280/285/ 430/435/440/445/460/ 465/480/485		Type-N, female, 50 Ω
Option 2D5/2K5/4D5/4K5		3.5 mm (male), 50 Ω nominal
Probe power		
Connector		3 terminal connector x 2
Voltage & maximum current	+15 V \pm 2% (400 mA) -12.6 V \pm 5% (300 mA) (Combined load for both probe connections)	
Display		
Type		10.4 in TFT color LCD with touch screen
Resolution		XGA (1024 x 768) ¹

1. Valid pixels are 99.99% and more. Below 0.01% (approx. 30 points) of fixed points of black, blue, green or red are not regarded as failure.

Table 30. Rear panel information

Description	Typical	General characteristics
External trigger input connector		
Type		BNC, female
Input level		Low threshold voltage: 0.5 V High threshold voltage: 2.1 V Input level range: 0 to + 5 V
Pulse width		$\geq 2 \mu\text{sec}$
Polarity		Positive or negative
External trigger output connector		
Type		BNC, female
Maximum output current		50 mA
Output level		Low level voltage: 0 V High level voltage: 5 V
Pulse width		1 μsec
Polarity		Positive or negative
External reference signal input connector		
Type		BNC, female
Input frequency	10 MHz ± 10 ppm	
Input level	-3 to + 10 dBm	
Internal reference signal output connector		
Type		BNC, female
Output frequency	10 MHz ± 7 ppm	
Signal type	Sinewave	
Output level	0 dBm ± 3 dB into 50 Ω	
Output impedance		50 Ω
Internal reference signal oven connector		
Type		BNC, female
Output frequency	10 MHz ± 1 ppm	
Output level	0 dBm minimum	

Table 31. Rear panel information (continued)

Description	Typical	General characteristics
Bias tee input connector		
Type		BNC, female (for each port)
Maximum voltage		±35 VDC
Maximum current (no degradation in RF specifications)		±200 mA
Maximum current (damage level)		±500 mA
Fuse		500 mA, bi-pin style
Video output		15-pin mini D-Sub; female; drives XGA compatible monitors
GPIB		24-pin D-Sub (Type D-24), female; compatible with IEEE-488 interface specification is designed to be used in environment where electrical noise is relatively low. LAN or USBTMC interface is recommended to use at the higher electrical noise environment.
USB-host port		
	Universal serial bus jack, Type A configuration (4 contacts inline, contact 1 on left); female; provides connection to printer, ECal module, USB/GPIB interface or multiport test set	
Contact 1		Vcc: 4.75 to 5.25 VDC, 500 mA, maximum
Contact 2		– Data
Contact 3		+ Data
Contact 4		Ground
USB (USBTMC ¹) interface port		Universal serial bus jack, Type B configuration (4 contacts inline); female; provides connection to an external PC; compatible with USBTMC-USB488 and USB 2.0.
LAN		10/100/1000 BaseT Ethernet, 8-pin configuration; auto selects between the two data rates
Handler I/O port		36-pin centronics, female; provides connection to handler system

Table 32. Rear panel information (continued)

Description	Typical	General characteristics
Line power²		
Frequency		47 Hz to 63 Hz
Voltage		90-264 VAC (V _{peak} > 120 V)
VA max		350 VA max.
Power Consumption		
Option 230/235/240/245/260/265/280/285		130 W (SPD)
Option 430/435/440/445/460/465/480/485		155 W (SPD)
Option 2D5/2K5		160 W (SPD)
Option 4D5/4K5		185 W (SPD)

Description	Specification	General characteristics
AUX input connector		
Type		BNC, female x 2
Input range		±1 V or ±10 V selectable
Accuracy	1 % + 1 mV for ±1 V input 1 % + 10 mV for ±10 V input	

Table 33. LXI compliance

Description	General characteristics
	Class C (only applies to units that are shipped with firmware revision A.08.00 or later)

1. USB Test and Measurement Class (TMC) interface that communicates over USB, complying with the IEEE 488.1 and IEEE 488.2 standards.
2. A third-wire ground is required.

Table 34. EMC, safety and environment





Description	General characteristics
EMC	
 ISM 1-A	<p>European Council Directive 2004/108/EC IEC 61326-1:2005 EN 61326-1:2006 CISPR 11:2003+A1:2004 EN 55011:2007 Group 1, Class A IEC 61000-4-2:1995 +A2:2000 EN 61000-4-2:1995 +A2:2001 4 kV CD / 8 kV AD IEC 61000-4-3:2006 EN 61000-4-3:2006 1-3 V/m, 80-1000 MHz / 1.4 GHz - 2.7 GHz, 80% AM IEC 61000-4-4:2004 EN 61000-4-4:2004 1 kV power lines / 0.5 kV signal lines IEC 61000-4-5:2005 EN 61000-4-5:2006 0.5 kV line-line / 1 kV line-ground IEC 61000-4-6:2003 + A1:2004+ A2:2006 EN 61000-4-6:2007 3 V, 0.15-80 MHz, 80% AM IEC 61000-4-11:2004 EN 61000-4-11:2004 0.5-300 cycle, 0% / 70%</p>
ICES/NMB-001	ICES-001:2006 Group 1, Class A
 N10149	AS/NZS CISPR11:2004 Group 1, Class A
Safety	
 ISM 1-A	<p>European Council Directive 2006/95/EC IEC 61010-1:2001 / EN 61010-1:2001 Measurement Category I Pollution Degree 2 Indoor Use</p>
 LR95111C	<p>CAN/CSA C22.2 No. 61010-1-04 Measurement Category I Pollution Degree 2 Indoor Use</p>
Environment	
	<p>This product complies with the WEEE Directive (2002/96/EC) marking requirements. The affixed label indicates that you must not discard this electrical/electronic product in domestic household waste.</p> <p>Product Category: With reference to the equipment types in the WEEE Directive Annex I, this product is classed as a "Monitoring and Control instrumentation" product.</p> <p>Do not dispose in domestic household waste.</p> <p>To return unwanted products, contact your local Keysight office, or see www.keysight.com/environment/product/ for more information.</p>

Table 35. Analyzer environmental specifications and dimensions

Description	General characteristics
Operating environment	
Temperature	+5 °C to +40 °C
Error-corrected temperature range	23 °C (±5 °C) with < 1 °C deviation from calibration temperature
Humidity	20% to 80% at wet bulb temperature < +29 °C (non-condensation)
Altitude	0 to 2,000 m (0 to 6561 feet)
Vibration	0.21 G maximum, 5 Hz to 500 Hz
Non-Operating storage environment	
Temperature	-10 °C to +60 °C
Humidity	20% to 90% at wet bulb temperature < +40 °C (non-condensation)
Altitude	0 to 4572 m (0 to 15,000 feet)
Vibration	0.5 G maximum, 5 Hz to 500 Hz
Dimensions	See next page.
Weight (net)	
Option 230/240/260/280 (2-port)	18.2 kg
Option 235/245/265/285 (2-port)	18.3 kg
Option 430/480/440/460 (4-port)	19.9 kg
Option 435/445/465/485 (4-port)	20.0 kg
Option 2D5/2K5 (2-port)	19.8 kg
Option 4D5/4K5 (4-port)	21.8 kg

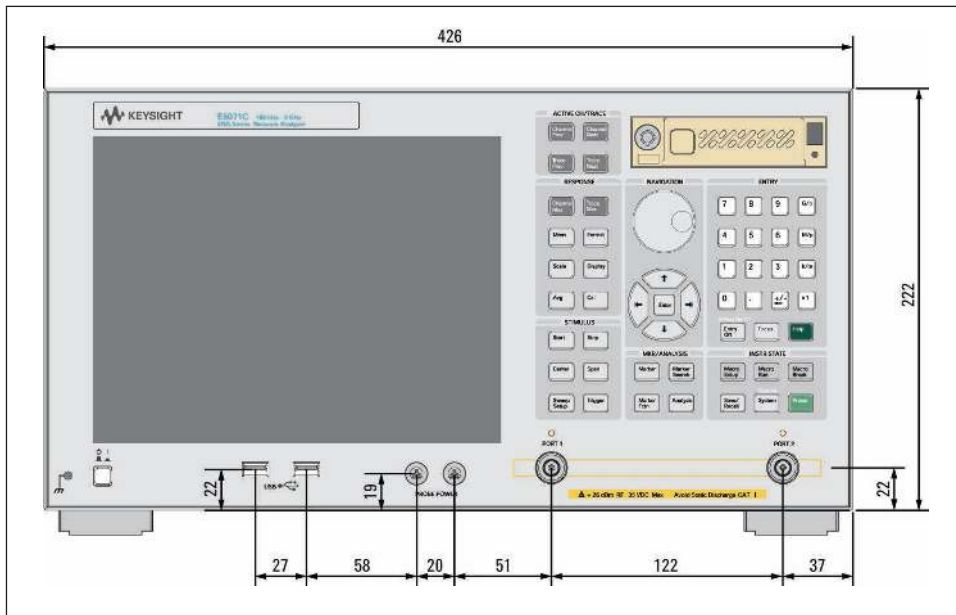

Figure 3. Dimensions (front view, E5071C with Option 230/235/240/245/260/265/280/285, in millimeters)

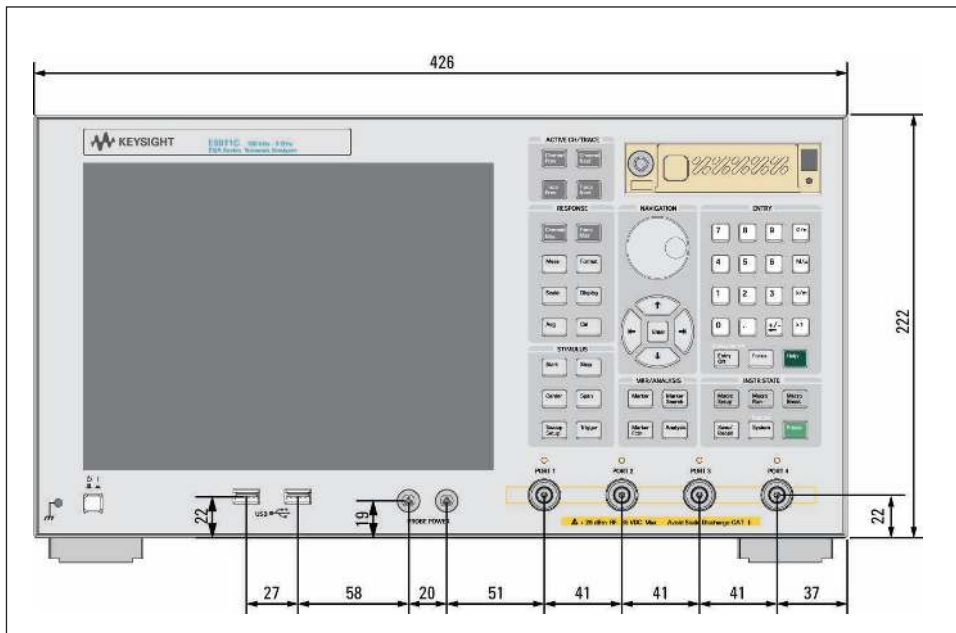

Figure 4. Dimensions (front view, E5071C with Option 430/435/440/445/460/465/480/485, in millimeters)

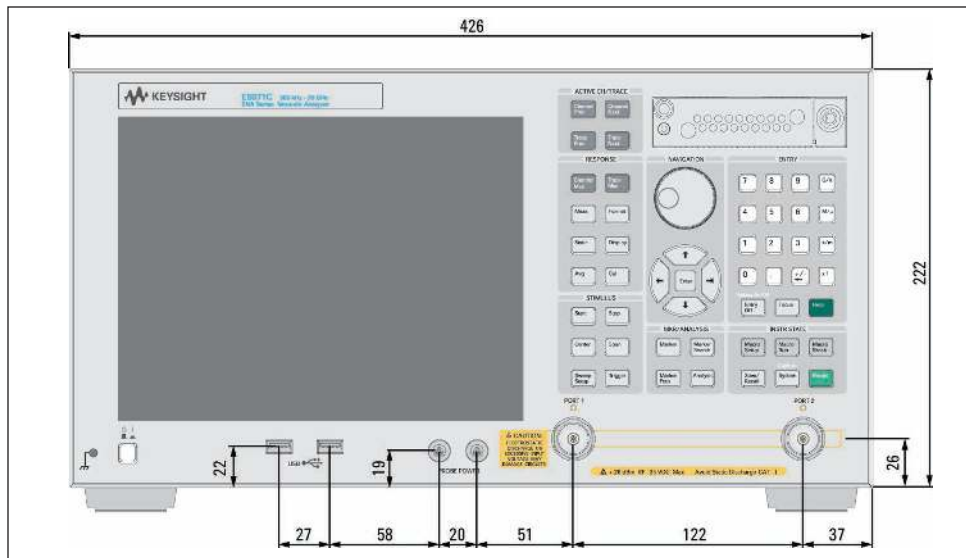

Figure 5. Dimensions (front view, E5071C with Option 2D5/2K5, in millimeters)

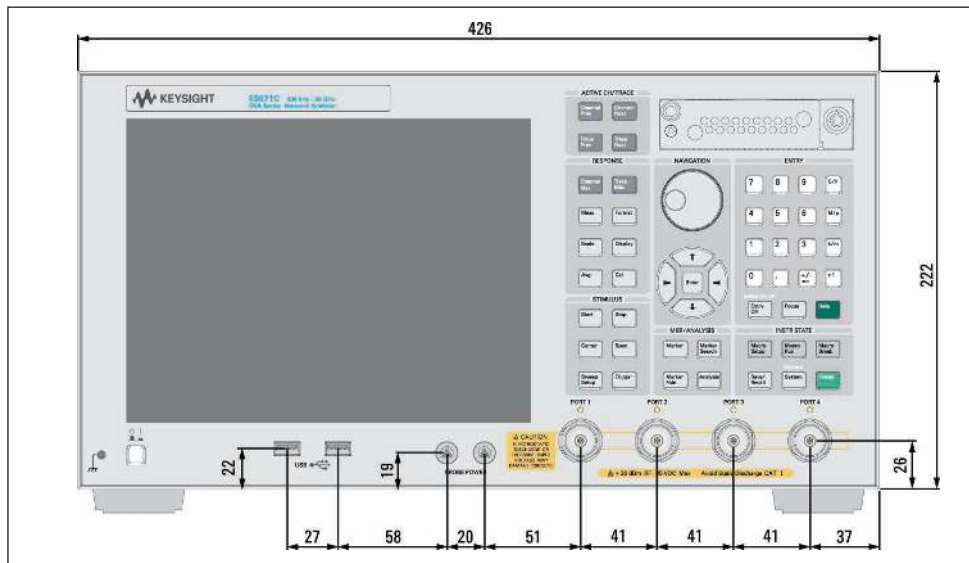

Figure 6. Dimensions (front view, E5071C with Option 4D5/4K5, in millimeters)

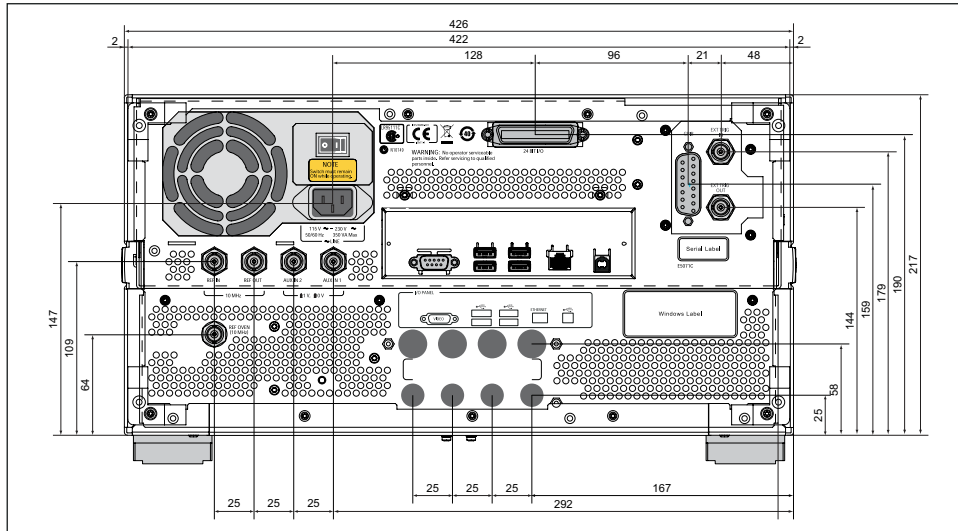

Figure 7. Dimensions (rear view with Option 1E5, in millimeters)

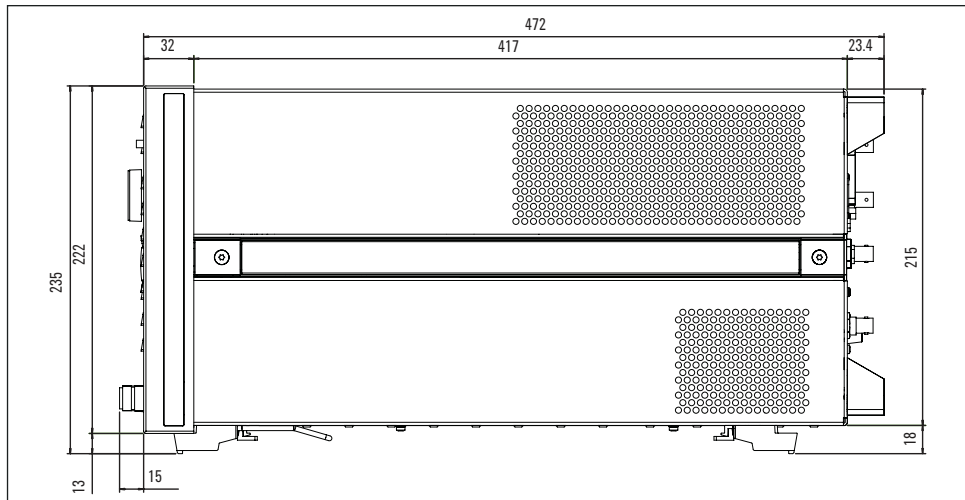

Figure 8. Dimensions (side view, E5071C Option 230/235/240/245/260/265/280/285/430/435/440/445/460/465/480/485, in millimeters)

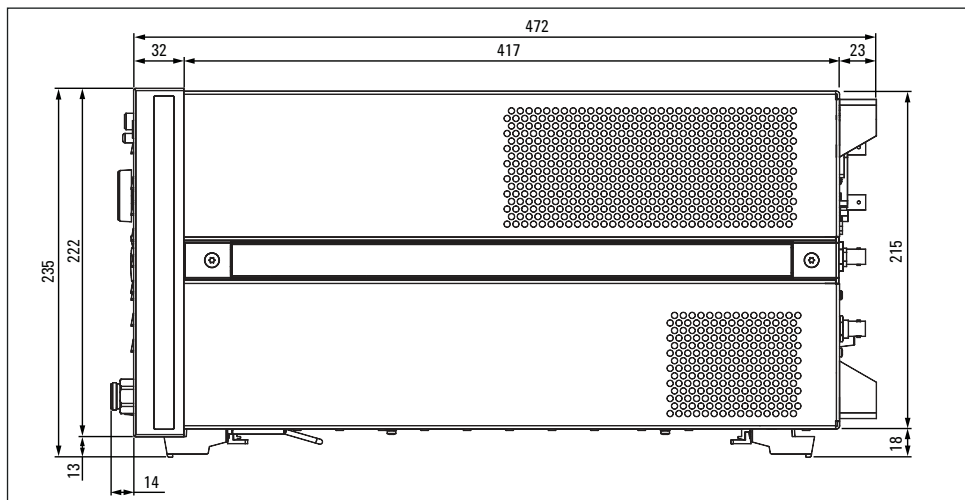

Figure 9. Dimensions (side view, E5071C with Option 2D5/2K5/4D5/4K5, in millimeters)

Measurement Throughput Summary^{1, 2}

Cycle time for measurement completion (ms)

Table 36. Option 240/245/260/265/280/285/440/445/460/465/480/485

Sweep mode: Swept, analyzer display turned off with: DISP:ENAB OFF,
number of traces = 1, system error correction: OFF

	Number of points			
	51	201	401	1601
Start 1 GHz, stop 1.2 GHz, 500 kHz IF bandwidth				
Uncorrected	4	5	7	17
2-port cal	6	9	12	33
4-port cal	12	17	24	66
Start 1 GHz, stop 1.2 GHz, 100 kHz IF bandwidth				
Uncorrected	4	5	7	19
2-port cal	7	9	13	37
4-port cal	12	18	26	73
Start 1 GHz, stop 1.2 GHz, 1 kHz IF bandwidth				
Uncorrected	53	200	395	1562
2-port cal	106	400	790	3123
4-port cal	211	799	1579	6245
Start 100 kHz, stop 4.5 GHz, 500 kHz IF bandwidth				
Uncorrected	11	13	14	23
2-port cal	20	25	27	45
4-port cal	40	49	53	95
Start 100 kHz, stop 4.5 GHz, 100 kHz IF bandwidth				
Uncorrected	11	13	14	25
2-port cal	21	25	27	49
4-port cal	40	50	54	102
Start 100 kHz, stop 4.5 GHz, 1 kHz IF bandwidth				
Uncorrected	56	205	402	1581
2-port cal	111	409	804	3162
4-port cal	222	818	1608	6323

1. Supplemental performance data.

2. Measured with firmware version B.12.03 with serial number prefix MY465.

Start 100 kHz, stop 8.5 GHz, 500 kHz IF bandwidth				
Uncorrected	14	18	19	23
2-port cal	28	35	37	45
4-port cal	55	69	74	90
Start 100 kHz, stop 8.5 GHz, 100 kHz IF bandwidth				
Uncorrected	14	18	19	25
2-port cal	28	35	37	49
4-port cal	55	69	74	98
Start 100 kHz, stop 8.5 GHz, 1 kHz IF bandwidth				
Uncorrected	56	205	403	1581
2-port cal	112	410	805	3162
4-port cal	224	820	1609	6322

Table 37. Option 240/245/260/265/280/285/440/445/460/465/480/485

Sweep mode: Stepped, analyzer display turned off with: DISP:ENAB OFF,
 number of traces = 1, system error correction: ON

	Number of points			
	51	201	401	1601
Start 1 GHz, stop 1.2 GHz, 500 kHz IF bandwidth				
Uncorrected	4	8	11	28
2-port cal	8	14	22	55
4-port cal	16	28	42	109
Start 1 GHz, stop 1.2 GHz, 100 kHz IF bandwidth				
Uncorrected	5	9	14	40
2-port cal	9	18	28	80
4-port cal	17	34	55	159
Start 1 GHz, stop 1.2 GHz, 1 kHz IF bandwidth				
Uncorrected	53	200	395	1562
2-port cal	106	400	790	3123
4-port cal	211	799	1579	6245
Start 100 kHz, stop 4.5 GHz, 500 kHz IF bandwidth				
Uncorrected	7	12	18	47
2-port cal	14	24	36	94
4-port cal	27	48	71	187
Start 100 kHz, stop 4.5 GHz, 100 kHz IF bandwidth				
Uncorrected	8	14	21	60
2-port cal	14	27	42	118
4-port cal	28	54	83	236
Start 100 kHz, stop 4.5 GHz, 1 kHz IF bandwidth				
Uncorrected	56	205	403	1581
2-port cal	111	409	804	3162
4-port cal	222	818	1608	6323
Start 100 kHz, stop 8.5 GHz, 500 kHz IF bandwidth				
Uncorrected	8	13	19	47
2-port cal	14	25	36	94
4-port cal	28	49	72	187
Start 100 kHz, stop 8.5 GHz, 100 kHz IF bandwidth				
Uncorrected	8	14	22	59
2-port cal	15	28	43	118
4-port cal	30	56	85	236
Start 100 kHz, stop 8.5 GHz, 1 kHz IF bandwidth				
Uncorrected	56	205	403	1581
2-port cal	112	410	805	3162
4-port cal	224	820	1609	6322

Table 38. Option 2D5/2K5/4D5/4K5

Sweep mode: Swept, analyzer display turned off with: DISP:ENAB OFF,
 number of traces = 1, system error correction: OFF

	Number of Points			
	51	201	401	1601
Start 11 GHz, stop 12 GHz, 500 kHz IF bandwidth				
Uncorrected	3	3	5	15
2-port cal	6	6	9	29
4-port cal	10	11	18	65
Start 11 GHz, stop 12 GHz, 100 kHz IF bandwidth				
Uncorrected	3	3	5	17
2-port cal	6	6	10	33
4-port cal	11	12	20	71
Start 11 GHz, stop 12 GHz, 1 kHz IF bandwidth				
Uncorrected	52	199	395	1565
2-port cal	103	397	789	3128
4-port cal	205	794	1577	6256
Start 8 GHz, stop 18 GHz, 500 kHz IF bandwidth				
Uncorrected	17	21	22	22
2-port cal	33	42	43	44
4-port cal	66	82	85	88
Start 8 GHz, stop 18 GHz, 100 kHz IF bandwidth				
Uncorrected	17	21	22	24
2-port cal	34	42	43	47
4-port cal	67	83	86	93
Start 8 GHz, stop 18 GHz, 1 kHz IF bandwidth				
Uncorrected	57	206	403	1581
2-port cal	114	411	805	3162
4-port cal	227	822	1610	6323
Start 300 kHz, stop 20 GHz, 500 kHz IF bandwidth				
Uncorrected	22	36	39	43
2-port cal	44	71	77	84
4-port cal	88	141	153	168
Start 300 kHz, stop 20 GHz, 100 kHz IF bandwidth				
Uncorrected	23	36	39	43
2-port cal	45	71	78	85
4-port cal	89	142	154	169
Start 300 kHz, stop 20 GHz, 1 kHz IF bandwidth				
Uncorrected	60	210	408	1590
2-port cal	118	420	816	3179
4-port cal	236	839	1630	6357

Table 39. Option 2D5/2K5/4D5/4K5

Sweep mode: Stepped, analyzer display turned off with: DISP:ENAB OFF,
 number of traces = 1, system error correction: ON

	Number of Points			
	51	201	401	1601
Start 11 GHz, stop 12 GHz, 500 kHz IF bandwidth				
Uncorrected	3	6	11	31
2-port cal	5	12	20	61
4-port cal	10	24	40	120
Start 11 GHz, stop 12 GHz, 100 kHz IF bandwidth				
Uncorrected	3	8	14	43
2-port cal	6	15	26	85
4-port cal	11	30	52	170
Start 11 GHz, stop 12 GHz, 1 kHz IF bandwidth				
Uncorrected	52	199	395	1565
2-port cal	103	397	789	3128
4-port cal	205	794	1577	6256
Start 8 GHz, stop 18 GHz, 500 kHz IF bandwidth				
Uncorrected	9	13	19	47
2-port cal	16	26	37	94
4-port cal	32	51	73	187
Start 8 GHz, stop 18 GHz, 100 kHz IF bandwidth				
Uncorrected	9	15	22	60
2-port cal	17	29	43	118
4-port cal	33	58	86	236
Start 8 GHz, stop 18 GHz, 1 kHz IF bandwidth				
Uncorrected	57	206	403	1581
2-port cal	114	411	805	3162
4-port cal	227	822	1610	6323
Start 300 kHz, stop 20 GHz, 500 kHz IF bandwidth				
Uncorrected	11	18	24	56
2-port cal	21	35	47	111
4-port cal	41	68	94	221
Start 300 kHz, stop 20 GHz, 100 kHz IF bandwidth				
Uncorrected	11	19	27	68
2-port cal	21	38	53	135
4-port cal	42	74	106	270
Start 300 kHz, stop 20 GHz, 1 kHz IF bandwidth				
Uncorrected	60	210	408	1590
2-port cal	118	420	816	3179
4-port cal	236	839	1630	6357

Cycle time (ms) vs. number of points

Table 40. Option 240/245/260/265/280/285/440/445/460/465/480/485

Start 1 GHz, stop 1.2 GHz, 500 kHz IF bandwidth, error correction: OFF,
display update: OFF, number of traces = 1

Number of points	Sweep mode: Swept, System error correction: OFF	Sweep mode: Stepped, System error correction: ON
51	4	4
201	5	8
401	7	11
1601	17	28

Table 41. Option 2D5/2K5/4D5/4K5

Start 11 GHz, stop 12 GHz, 500 kHz IF bandwidth, error correction: OFF,
display update: OFF, number of traces = 1

Number of points	Sweep mode: Swept, System error correction: OFF	Sweep mode: Stepped, System error correction: ON
51	3	3
201	3	6
401	5	11
1601	15	31

Cycle time (ms) vs. IF bandwidth

Table 42. 240/245/260/265/280/285/440/445/460/465/480/485

Sweep mode: Swept, analyzer display turned off with: DISP: ENAB OFF,
number of traces = 1, system error correction: OFF, Frequency = 4 GHz, NOP = 201

IF BW [Hz]	Cycle time [ms]	IF BW [Hz]	Cycle time [ms]	IF BW [Hz]	Cycle time [ms]	IF BW [kHz]	Cycle time [ms]	IF BW [kHz]	Cycle time [ms]	IF BW [kHz]	Cycle time [ms]
10	19300	100	1933	1000	196	10	22	100	5	1000	5
15	12868	150	1290	1500	132	15	16	150	5	1500	5
20	9652	200	968	2000	100	20	13	200	5		
30	6436	300	647	3000	68	30	9	300	5		
40	4827	400	486	4000	52	40	8	400	5		
50	3863	500	389	5000	42	50	7	500	5		
70	2737	700	277	7000	30	70	6	700	5		

Table 43. Option 2D5/2K5/4D5/4K5

Sweep mode: Swept, analyzer display turned off with: DISP: ENAB OFF,
number of traces = 1, system error correction: OFF, Frequency = 10 GHz, NOP = 201

IF BW [Hz]	Cycle time [ms]	IF BW [Hz]	Cycle time [ms]	IF BW [Hz]	Cycle time [ms]	IF BW [kHz]	Cycle time [ms]	IF BW [kHz]	Cycle time [ms]	IF BW [kHz]	Cycle time [ms]
10	19328	100	1931	1000	194	10	20	100	3	1000	3
15	12890	150	1288	1500	130	15	14	150	3	1500	3
20	9670	200	966	2000	98	20	11	200	3		
30	6448	300	645	3000	66	30	7	300	3		
40	4836	400	484	4000	50	40	6	400	3		
50	3868	500	387	5000	40	50	5	500	3		
70	2737	700	275	7000	28	70	4	700	3		

Cycle time (ms) vs. RF Range Fixed Mode

Table 44. Option 230/235/240/245/260/265/280/285/430/435/440/445/460/465/480/485

Sweep mode: Swept, analyzer display turned off with: DISP:ENAB OFF,
number of traces = 1, system error correction: OFF, Start 1 GHz, stop 1.2 GHz, 500 kHz IF
bandwidth

	Number of points			
	51	201	401	1601
RF Range Fixed Mode: ON				
Uncorrected	2	3	5	15
2-port cal	2	5	8	29
4-port cal	4	9	16	58
RF Range Fixed Mode: OFF				
Uncorrected	4	5	7	17
2-port cal	6	9	12	33
4-port cal	12	17	24	66

Sweep mode: Swept, analyzer display turned off with: DISP:ENAB OFF,
number of traces = 1, system error correction: OFF, Start 1 GHz, stop 1.2 GHz, 100 kHz IF
bandwidth

	Number of points			
	51	201	401	1601
RF Range Fixed Mode: ON				
Uncorrected	2	3	5	17
2-port cal	3	5	9	33
4-port cal	4	10	18	65
RF Range Fixed Mode: OFF				
Uncorrected	4	5	7	19
2-port cal	7	9	13	37
4-port cal	12	18	26	73

Data transfer time (ms)^{1, 2}

Table 45. All options

	Number of points			
	51	201	401	1601
SCPI over GPIB³				
64-bit floating point	4	12	23	88
32-bit floating point	3	7	12	45
ASCII	9	34	68	267
SCPI over 1 Gbps LAN (Socket)³				
REAL 64	1	1	1	2
REAL 32	1	1	1	2
ASCII	6	21	40	155
SCPI over 1 Gbps LAN (SICL-LAN)³				
REAL 64	4	4	4	5
REAL 32	4	4	4	4
ASCII	4	6	9	25
SCPI over USB (SICL-USB)³				
REAL 64	2	2	2	2
REAL 32	2	2	2	2
ASCII	2	6	10	38
SCPI over GPIB/USB (82357B)				
REAL 64	8	15	24	85
REAL 32	6	10	15	45
ASCII	75	282	561	2235
COM⁴				
Variant type	1	1	1	1

1. Supplemental performance data. Data transfer time varies depending on the type of PC and control software.
2. Measured with firmware version B.12.03 with serial number prefix MY465.
3. Transferred complex S_{11} data, using :CALC{1-36}:DATA:FDAT?.
4. Measured using an E5071C VBA macro running inside the analyzer. Transferred complex S_{11} data.

E5092A Configurable multiport test set

The section provides test input/output performance without calibration by the E5071C.

Table 46. Test set input/output performance

Description	Specification	Typical
Frequency range	50 MHz to 20 GHz	
Damage level		20 dBm, ± 35 VDC

Table 47. Option E5092A-020 port performance

Description	Specification	Typical
Load match (selected port)		
SPDT switch ¹		
50 MHz to 2 GHz	17 dB	
2 GHz to 4 GHz	11 dB	
4 GHz to 8 GHz	8 dB	
8 GHz to 10 GHz	7 dB	
10 GHz to 18 GHz	4 dB	
18 GHz to 20 GHz	4 dB	
SP4T switch ²		
50 MHz to 2 GHz	17 dB	
2 GHz to 3 GHz	11 dB	
3 GHz to 8 GHz	8 dB	
8 GHz to 10 GHz	7 dB	
10 GHz to 18 GHz	4 dB	
18 GHz to 20 GHz	4 dB	
Load match (unselected port)		
SPDT switch ¹		
50 MHz to 3 GHz	17 dB	
3 GHz to 10 GHz	11 dB	
10 GHz to 16 GHz	8 dB	
16 GHz to 18 GHz	6 dB	
18 GHz to 20 GHz	4 dB	
SP4T switch ²		
50 MHz to 3 GHz	17 dB	
3 GHz to 10 GHz	11 dB	
10 GHz to 16 GHz	8 dB	
16 GHz to 18 GHz	6 dB	
18 GHz to 20 GHz	4 dB	

1. SPDT: Single-pole-double-throw switches. Applies to SW5, SW6, SW7, SW8, SW9 and SW10 in the E5092A. (See Figure 20.)

2. SP4T: Single-pole-four-throw switches. Applies to SW1, SW2, SW3 and SW4 in the E5092A. (See Figure 20.)

Table 48. Option E5092A-020 port performance (continued)

Description	Specification	Typical
Load match (common port)		
SPDT switch ¹		
50 MHz to 2 GHz	16 dB	
2 GHz to 4 GHz	11 dB	
4 GHz to 8 GHz	8 dB	
8 GHz to 10 GHz	7 dB	
10 GHz to 20 GHz	4 dB	
SP4T switch ²		
50 MHz to 1.3 GHz	16 dB	
1.3 GHz to 4 GHz	11 dB	
4 GHz to 8 GHz	8 dB	
8 GHz to 10 GHz	7 dB	
10 GHz to 20 GHz	4 dB	
Insertion loss		
SPDT switch ¹		
50 MHz to 100 MHz	4 dB	
100 MHz to 2 GHz	3.5 dB	
2 GHz to 3 GHz	4.5 dB	
3 GHz to 4 GHz	5 dB	
4 GHz to 6 GHz	5.5 dB	
6 GHz to 8 GHz	7 dB	
8 GHz to 10 GHz	8 dB	
10 GHz to 14 GHz	8.5 dB	
14 GHz to 18 GHz	10 dB	
18 GHz to 20 GHz	11.5 dB	
SP4T switch ²		
50 to 100 MHz	4 dB	
100 MHz to 2 GHz	3.5 dB	
2 GHz to 3 GHz	4.5 dB	
3 GHz to 4 GHz	5.5 dB	
4 GHz to 6 GHz	6 dB	
6 GHz to 8 GHz	7.5 dB	
8 GHz to 10 GHz	8.5 dB	
10 GHz to 14 GHz	9.5 dB	
14 GHz to 18 GHz	10.5 dB	
18 GHz to 20 GHz	12 dB	
Stability per switch		
Condition: Environment Temperature +23 °C ±3 °C and Internal DC source: ≤ 100 mA (Sum of 4 channels), no heat source and no wall close to the unit.		
50 M to 4 GHz		0.003 dB/°C (SPD)
4 G to 12 GHz		0.005 dB/°C (SPD)
12 G to 20 GHz		0.008 dB/°C (SPD)
Condition: besides the above		
50 M to 4 GHz		0.007 dB/°C (SPD)
4 G to 12 GHz		0.012 dB/°C (SPD)
12 G to 20 GHz		0.017 dB/°C (SPD)
Isolation ³		
50 MHz to 500 MHz	65 dB	
500 MHz to 1 GHz	80 dB	
1 GHz to 2 GHz	85 dB	
2 GHz to 6 GHz	90 dB	
6 GHz to 10 GHz	85 dB	
10 GHz to 18 GHz	75 dB	
18 GHz to 20 GHz	65 dB	
	(Over arbitrarily test ports)	

1. SPDT: Single-pole-double-throw switches. Applies to SW5, SW6, SW7, SW8, SW9 and SW10 in the E5092A. (See Figure 20.)

2. SP4T: Single-pole-four-throw switches. Applies to SW1, SW2, SW3 and SW4 in the E5092A. (See Figure 20.)

3. This specification is defined when all ports are terminated with a 50 ohm load.

Table 49. Control line

Description	Specification	Typical
Number of groups	4 Group A: 8 bits Group B,C,D: 4 bits	
Input voltage range ¹	0 V to +5 V (positive input) –5 V to 0 V (negative input)	
Maximum current	Group A, B: 50 mA in total of each group Group C, D: 500 uA in total of each group	
Impedance		Group A, B: < 10 ohm Group C, D: < 200 ohm

Table 50. DC source

Description	Specification	Typical
Number of sources	4	
Output voltage range		0 V to +5.2 V (nominal) ²
Output voltage accuracy	±3 % of setting (+1 V to +5 V) at 1 M ohm load impedance	
Voltage resolution		10 mV (nominal) ³
Maximum current	150 mA for each source	
Output impedance		< 5 ohm

Table 51. Operating storage environment

Description	General characteristics
Temperature	+5 °C to +40 °C
Humidity	20 to 80 % at wet bulb temperature < +29 °C (non-condensing)
Altitude	0 to 2,000m (0 to 6,561 feet)
Vibration	0.21 G max., 5 to 500 Hz

Table 52. Non-operating storage environment

Description	General characteristics
Temperature	–10 °C to +60 °C
Humidity	20 to 90 % at wet bulb temperature < +40 °C (non-condensing)
Altitude	0 to 4,572 m (0 to 15,000 feet)
Vibration	0.5 G max., 5 Hz to 500 Hz

1. Input voltage will be clipped at about ±5.2 V when over this range.
2. The output voltage can be set in this range.
3. The output voltage resolution becomes effective between 0 V to 5.2 V.

Table 53. Front panel information

Description	General characteristics
RF connectors	SMA (Female)
Test ports	38 ports
Control line	15-pin D-sub, female 25-pin D-sub, female

Table 54. Rear panel information

Description	General characteristics
USB port	Type B-receptacle, provide connection to the E5071C
Line power ¹	
Frequency	47 to 63 Hz
Voltage	90 to 132 VAC, or 198 to 264 VAC (automatically switched)
VA max	300 VA max.

Table 55. Test set dimensions and block diagram

Description	General characteristics
Dimensions E5092A Option 020	See Figures 16, 17, 18 and 19
Weight E5092A Option 020	9 kg

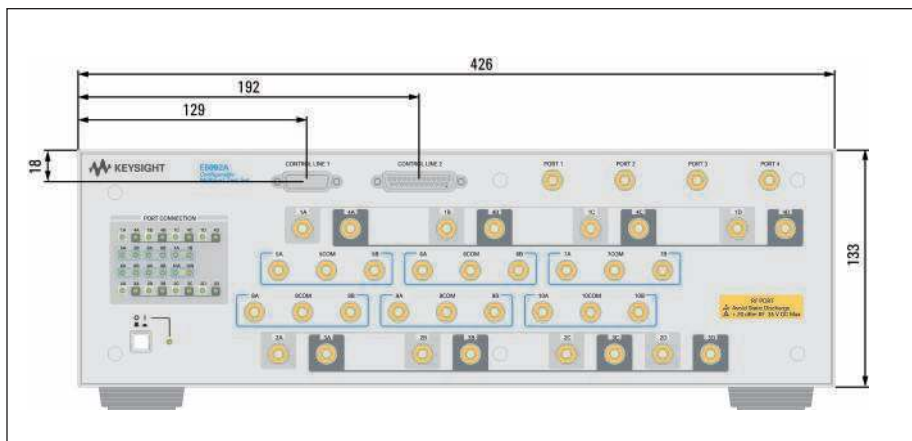

Figure 10. Dimensions (front view, with Option E5092A-020, in millimeters, nominal)

1. 1A third-wire ground is required.

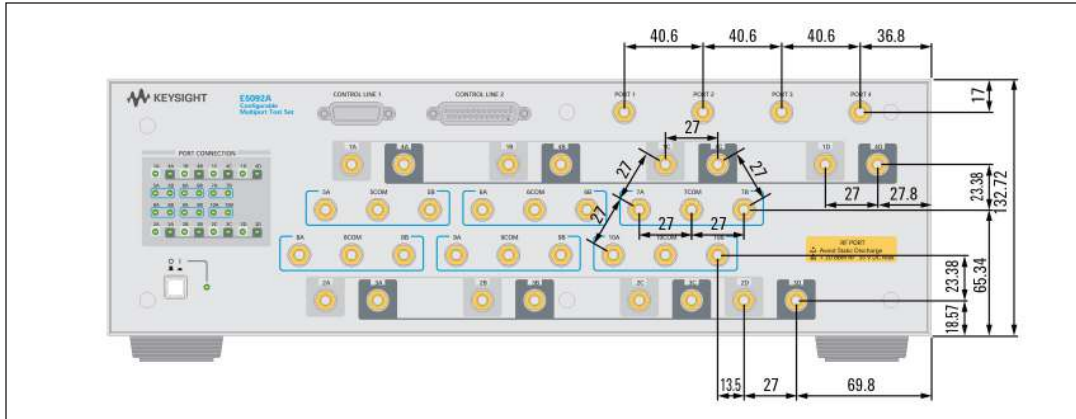

Figure 11. Dimensions (pitch between switches, with Option E5092A-020, in millimeters, nominal)

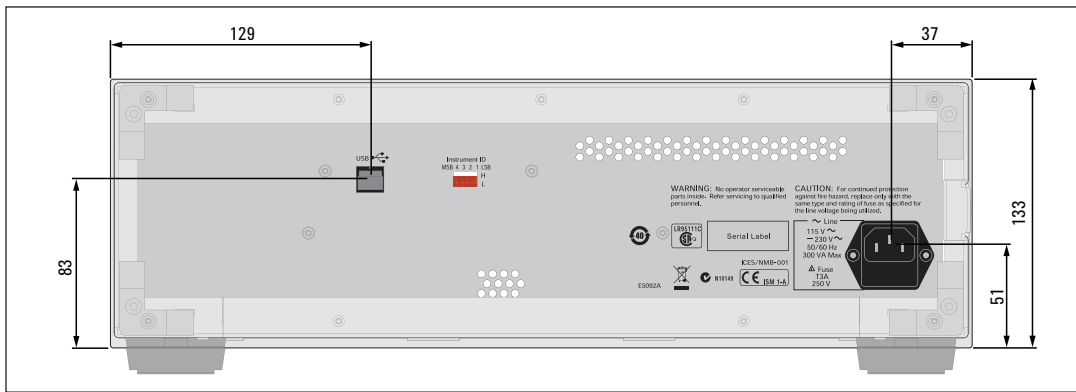

Figure 12. Dimensions (rear view, with Option E5092A-020, in millimeters, nominal)

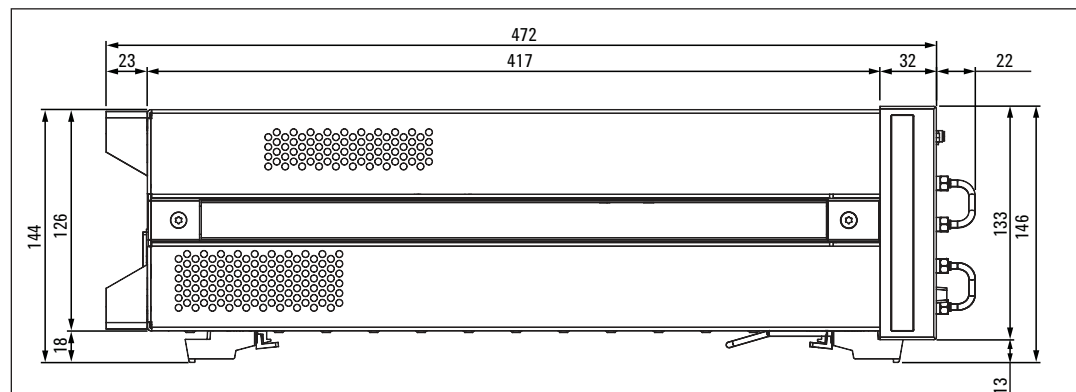

Figure 13. Dimensions (side view, with Option E5092A-020, in millimeters, nominal)

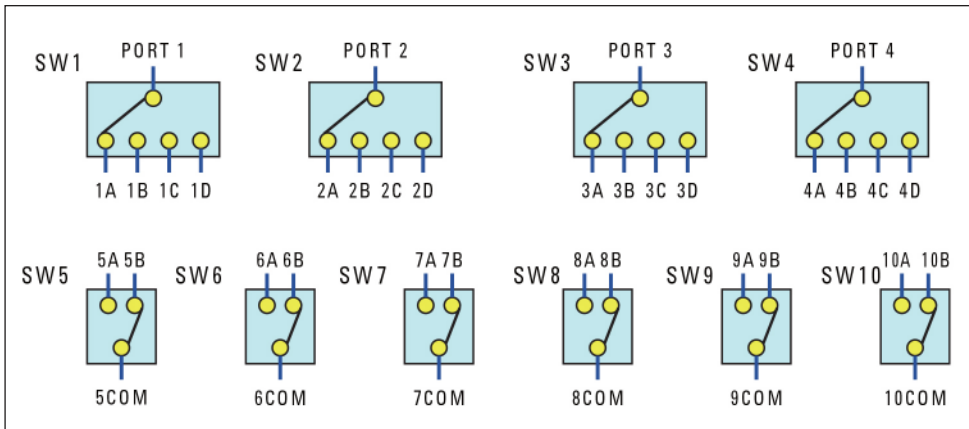

Figure 14. Switch configuration (E5092A-020)

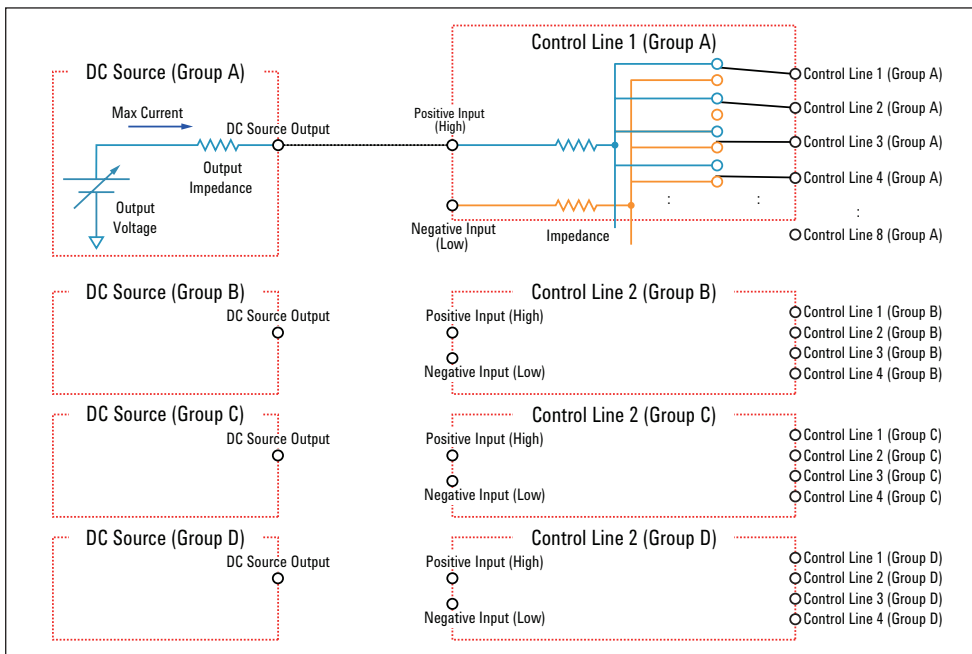

Figure 15. DC control line (E5092A-020)

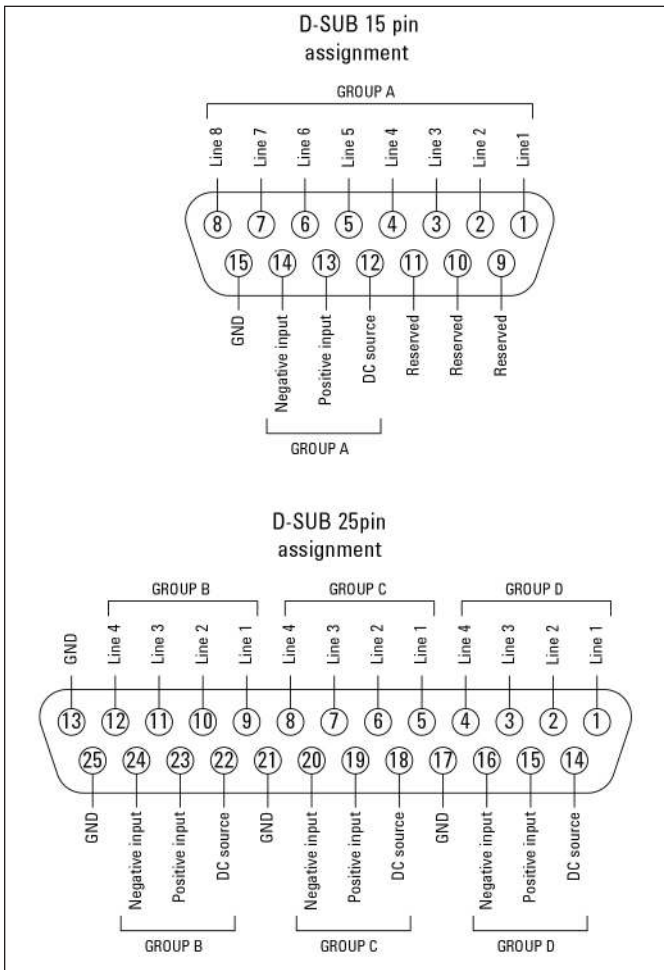

Figure 16. Control line pin assignment (E5092A-020)

Corrected System Performance for 75 Ω Measurements with 11852B 50 to 75 Ω Minimum-Loss Pads (Supplemental Information)

Option 230/235/240/245/260/265/280/285/430/435/440/445/
460/465/480/485

**Table 56. Corrected system performance with type-N 75 Ω device connectors,
85036E calibration kit**

Network analyzer: E5071C
calibration kit: 85036E (type-N 75 Ω)
50 to 75 Ω adapters: 11852B
calibration: full 2-port

IF bandwidth = 10 Hz, no averaging applied to data, environmental temperature = 23 °C ±5
°C with < 1 °C deviation from calibration temperature, isolation calibration performed

Description	Typical (dB)
	10 MHz to 3 GHz
Directivity	37
Source match	33
Load match	39
Reflection tracking	±0.015
Transmission tracking	±0.019

Transmission uncertainty 10 MHz to 3 GHz (typical)

Magnitude

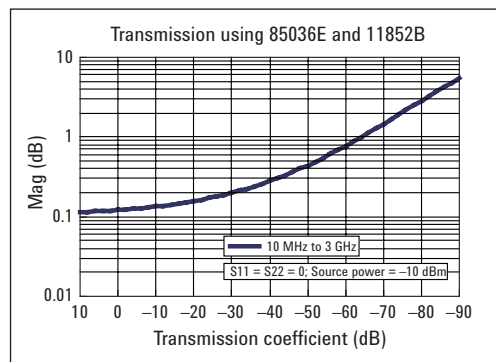

Phase

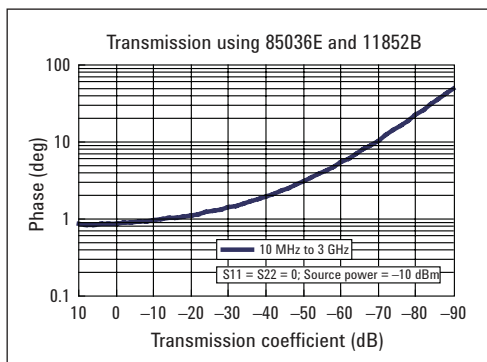

Reflection uncertainty 10 MHz to 3 GHz (typical)

Magnitude

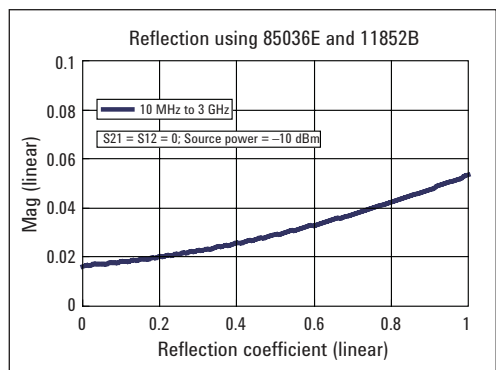

Phase

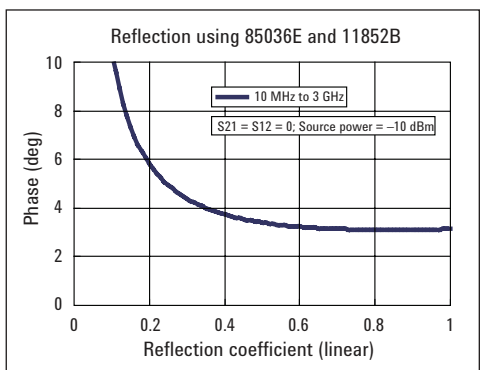

myKeysight

myKeysight

www.keysight.com/find/mykeysight

A personalized view into the information most relevant to you.



www.axiestandard.org

AdvancedTCA[®] Extensions for Instrumentation and Test (AXIe) is an open standard that extends the AdvancedTCA for general purpose and semiconductor test. Keysight is a founding member of the AXIe consortium. ATCA[®], AdvancedTCA[®], and the ATCA logo are registered US trademarks of the PCI Industrial Computer Manufacturers Group.



www.lxistandard.org

LAN eXtensions for Instruments puts the power of Ethernet and the Web inside your test systems. Keysight is a founding member of the LXI consortium.



www.pxisa.org

PCI eXtensions for Instrumentation (PXI) modular instrumentation delivers a rugged, PC-based high-performance measurement and automation system.



Three-Year Warranty

www.keysight.com/find/ThreeYearWarranty

Keysight's commitment to superior product quality and lower total cost of ownership. The only test and measurement company with three-year warranty standard on all instruments, worldwide.



Keysight Assurance Plans

www.keysight.com/find/AssurancePlans

Up to five years of protection and no budgetary surprises to ensure your instruments are operating to specification so you can rely on accurate measurements.



www.keysight.com/go/quality

Keysight Technologies, Inc.
DEKRA Certified ISO 9001:2008
Quality Management System

Keysight Channel Partners

www.keysight.com/find/channelpartners

Get the best of both worlds: Keysight's measurement expertise and product breadth, combined with channel partner convenience.

www.keysight.com/find/ena

For more information on Keysight Technologies' products, applications or services, please contact your local Keysight office. The complete list is available at: www.keysight.com/find/contactus

Americas

Canada	(877) 894 4414
Brazil	55 11 3351 7010
Mexico	001 800 254 2440
United States	(800) 829 4444

Asia Pacific

Australia	1 800 629 485
China	800 810 0189
Hong Kong	800 938 693
India	1 800 112 929
Japan	0120 (421) 345
Korea	080 769 0800
Malaysia	1 800 888 848
Singapore	1 800 375 8100
Taiwan	0800 047 866
Other AP Countries	(65) 6375 8100

Europe & Middle East

Austria	0800 001122
Belgium	0800 58580
Finland	0800 523252
France	0805 980333
Germany	0800 6270999
Ireland	1800 832700
Israel	1 809 343051
Italy	800 599100
Luxembourg	+32 800 58580
Netherlands	0800 0233200
Russia	8800 5009286
Spain	800 000154
Sweden	0200 882255
Switzerland	0800 805353
	Opt. 1 (DE)
	Opt. 2 (FR)
	Opt. 3 (IT)
United Kingdom	0800 0260637

For other unlisted countries:
www.keysight.com/find/contactus
(BP-09-23-14)

