

Elgar SmartWave Series

1750–22200 VA

High Performance AC/DC Power Source

156–312 V

- Arbitrary waveforms
- Compliance testing for Airbus, DO-160 and Boeing standards
- 2Hz to 6kHz standard output frequencies
- Crest factors up to 4
- Parallel up to 22.2KVA



6.5–192 A

⚡	208	230	400
⚡			230



The Elgar SmartWave™ (SW) Series of AC power sources offers powerful waveform creation for ATE and power line disturbance simulation testing. Three separate arbitrary waveform generators enable the SmartWave to create independent, complex waveforms on all three phases simultaneously. The SmartWave is designed to meet waveform requirements including DC content (up to 312V), low distortion (THD 0.25% to 100 Hz), low noise and ripple, plus full compliance testing to many EMC and avionics standards.

At only 8-3/4 inches high for the SW 5250A, the SmartWave delivers the most power in the smallest package. The SW Series is expandable from 1.75 kVA to 22.2 kVA. Unlike other AC power sources, the SmartWave delivers full rated power to 45°C..

Features and Benefits

Powerful Waveshape and Waveform Creation The SmartWave can easily create fractional or multi-cycle dropouts, spikes, surges, sags and distorted waveforms from the front panel. To simulate

these complex real-world power occurrences, the SmartWave comes with a library of 50 built-in waveshapes (see examples on page 74). Users can create and store an additional 50 waveshapes of their own design. Output voltages are created by adding amplitude, frequency and other parameters to the waveshapes. The user can also create over 50 custom front panel setups with all parameters included and store them for quick recall, making the SmartWave ideal for manual testing.

Sequence Programming

Complex sequence or event programming is easy with time or cycle based transient segments. The sequence library is made up of a total of 1000 segments. A sequence of up to 100 segments using up to 32 different waveshapes, arranged in any combination, can be run at any one time. The 32 waveshapes can be selected from the 50 factory supplied and 50 user created waveshapes. By setting the time or number of cycles for each segment, the user can create waveform sequences that allow automatic testing for most any standard.

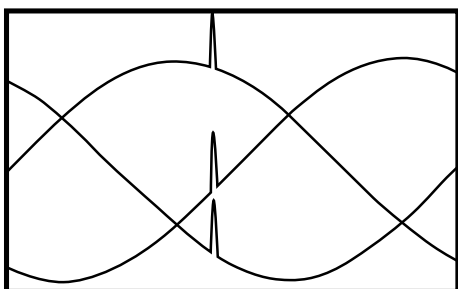

True simulation of time coincident events on a 3 phase power line using 3 internal ARB Generators

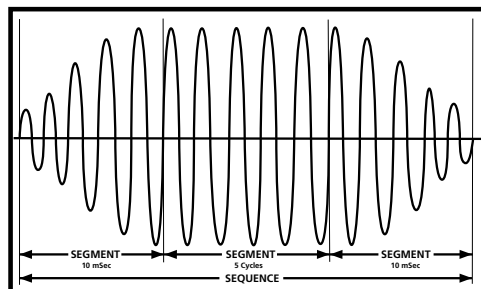

Sequences can be constructed with segments defined by time or number of cycles.

SW Series

AC and/or DC

A direct coupled, transformerless design allows AC and DC on separate phases or on the same phase. The SmartWave can be used as a true DC power supply. High DC content waveforms (up to 312 volts) can be created with no derating of output power, even with 100% reactive loads, eliminating the need for a separate DC supply. Waveform Programming Software (Optional) Waveform programming is easily accomplished using the optional DSP PC software. The software allows freehand creation of waveforms, using a mouse or mathematical expressions. Waveforms can be uploaded and modified from a digital scope. The waveforms can then be downloaded to the SmartWave via GPIB and output to exactly simulate real-world conditions.

Flexibility in Power Ranges

The SmartWave series includes the SW 1750/1850 (single phase only), SW 3500/3700 (single or dual phase), and SW5550. The 5250A three phase unit can be switched to single phase or vice versa, simply by menu selection (and appropriate output wiring changes). The SW Series is factory upgradable from 1750 VA to 3500 VA or 5250 VA. Utilizing a master/slave arrangement, SW5250A can be paralleled for incrementally higher power requirements, e.g. one master/one slave= SW10500 (10.5 kVA). As many as 3 slave chassis may be paralleled with a master to form a 21 kVA system. Options include input power factor correction, measurement capability, plus 5 and 26 VAC auxiliary outputs.

Waveshape Library

There are 50 factory-supplied waveshapes in the SmartWave. Following are examples of the types of waveshapes in the library:

- Sine wave
- Square wave
- Triangle wave
- Clipped sine waves
- Sine waves with spikes
- Fractional dropouts
- Sine wave with dropout (0V from 0° to 90°)
- Sine waves with $\pm 1-50\%$ DC offset
- $\pm DC$ with 3% and 10% ripple
- Fourier square waves with harmonics
- Taylor series waves
- Sine wave with noise at zero crossing

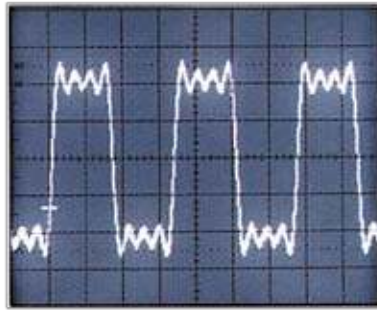

Fourier square wave with first, third, fifth and seventh harmonics.

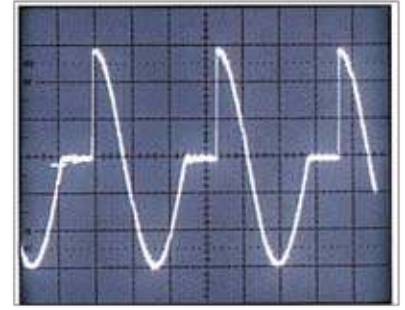

Sine wave with first quarter (0°-90°) at 0 volts (inrush).

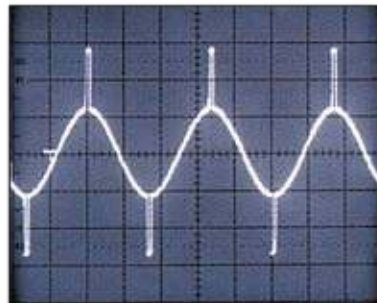

Sine wave with spikes at 85°-95°.

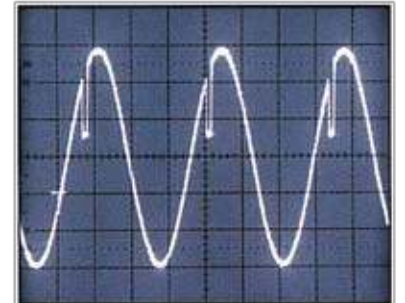

Sine wave with a dropout from 45°-60°.

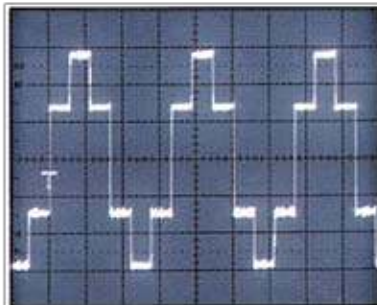

Six Voltage step sine wave.

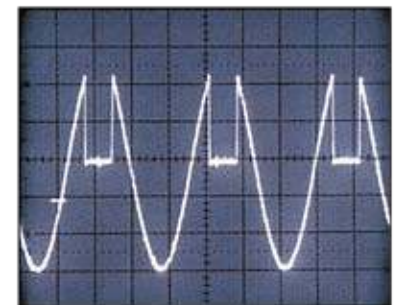

Sine wave with the positive halfcycle clipped at 0V from 50°-130°.

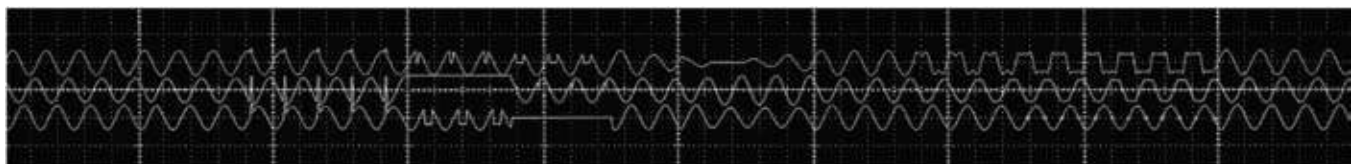

As shown by this photo, the SmartWave can create time coincident spikes on 3 phases, fractional or multi-cycle dropouts, sags and surges, waveforms distortion, DC and noise.

APPLICATIONS

The SmartWave is designed for testing today's complex electronics, including avionics, telecommunications and commercial electronics requiring low profile, light weight power supplies. Other applications include:

- Testing for real world power conditions using different waveforms on all 3 phases (including DC)
- Load susceptibility testing with sequence or event programming and multiple voltage harmonics
- Power line disturbance simulation testing
- MIL-STD-704, DO-160 and ABD100 avionics testing
- Power supply testing for AC-DC, DC-DC converters and UPS's
- Fluorescent lighting characteristics testing (IES LM-41-1985)
- Transients on 12 & 24 VDC for automotive applications

SMARTWAVE CONTROL SUITE (SWCS)

The SmartWave™ Control Suite is a complete Windows®-based graphical GPIB control software package for the Elgar SmartWave (SW) and SWAE product lines. It provides a simple, yet powerful, method to actively control the SW, create and edit waveforms and sequences, as well as log measurements to your PC. Comprised of six interactive windows (or tabs) SWCS provides the following SW control features:

Program Settings: Direct setting of most common parameters such as voltage, frequency, current limit, phase angle and waveform type.

Measurements: Provides a strip-chart like recording of up to four measurements. Results may be viewed and logged to a file.

Waveform: Allows creation and editing of waveforms using several powerful methods, including defining a waveform by harmonic content.

Sequence: Simplifies setup, debugging and running of waveform sequences.

Instrument: Provides setting and modifications to configuration changes such as voltage range, coupling and shutdown method.

System: Gives user access to less common features of the SW, as well as allowing direct GPIB command control.

System Requirements:

- Pentium II 500Hz or greater
- 256MB RAM
- 500GB available hard disk space
- Microsoft Windows 95/98/NT/W2K/XP
- National Instruments GPIB card or GPIB-ENET (GPIB to Ethernet converter box) or GPIB-PCMCIA

SW Series : Product Specifications

Common	
Standard Features	<ul style="list-style-type: none"> • 1ø to 3ø programmable • BNC outputs for scope viewing of waveforms (1 MΩLoad Drive)
Interface	IEEE-488.2 interface
Protocol	SCPI protocol
WaveForm trigger output	(1 MΩLoad Drive)
Sync OUT	User programmed for: Cycle start, all cycles. Segment start, all or selected segments. For loads ≥ 2 kΩ: V out ≤ 1 V low state; V out ≥ 2.4 V high state
Clock/lock	Clock - pulses at programmed frequency. For loads ≥ 2 kΩV out: ≤ 1 V low state; V out ≥ 2.4 V high state Lock - locks output to input 'TTL' frequency; signal needs to supply pull down current of 15 mA with voltage drop of ≤ 0.6 V; no pull up needed
External Amplitude Modulation	0 to 5 Vrms provides 0 to ≥ 20 % output amplitude modulation
External Drive	Normal amplifier, 0 to 5 Vrms (DC to 5 kHz) or ± 5 VDC input for zero to full voltage output
External Gain Control	0 to ± 7.07 VDC provides zero to full output
External Input Impedance	≥ 30 kΩ
Input	
Voltage Ranges	Factory configured 187 to 264 Vrms, 3ø L-L (3 wire), or 342 to 457 Vrms, 3ø L-L (4 wire). A chassis ground is also required. 115 or 230 VAC single-phase is required for PDU in 10.5-21 kVA systems. (400 Hz input allowed with PFC option)
Power Factor	0.6 (.35 for Intl. Rectifier; 0.99 with PFC option) Note: With PFC option the inputs may be paralleled and wired for single phase input. Consult factory.
Frequency Range	47 to 63 Hz
Efficiency	70% min, at full load
Ride Through	3 ms min.; 10 ms min., with PFC option
Output	
Power	1750/1850 VA: 1ø, 3500/3700 VA: 1ø or 2ø, 5250/5550 VA: 1ø or 3ø (systems up to 22,200 VA)
AC or DC Output Voltage	0 to 156 Vrms L-N, range 1; 0 to 312 Vrms L-N, range 2
Current Per Phase	13/16A to 135V in 156V range; 6.5/13A to 270V in 312V range per 1750/1850 VA module. Note: Higher currents may be achieved in 10.5-21 kVA systems.
Power Factor of Load	0 to unity
Crest Factor	4.0 (peak output current to rms output current)
Frequency Range	DC or 2Hz to 6 kHz. Specifications apply DC, 40Hz to 5kHz. For output frequencies greater than 1 kHz, the max slew rate allowed is 1 kHz per second.
Max Total Harmonic Distortion	(Full Linear Load or No Load): 0.25% max, 40 to 100 Hz; 0.5% max to 500 Hz; and 1% max to 1 kHz plus 1%/kHz to 5 kHz
AC Noise Level	>60 dB rms below full output voltage
Amplitude Stability With Remote Sense	± 0.1 % of full scale over 24 hours at constant line, load and temperature
Line Regulation	(DC, or 40 Hz to 5 kHz): ± 0.025 % of full scale for a ± 10 % input line change
Load Regulation	± 0.025 % of full scale voltage for a full resistive load to no load; above 1 kHz, add ± 0.01 %/kHz
Voltage Accuracy	± 0.1 % of range. Above 1 kHz, add 0.2%/kHz. Add ± 0.1 % of full scale for "AC PLUS DC" mode. Valid for 5 to 156 Vrms and 10 to 312 Vrms at 25°C
Voltage Resolution	0.05% of full scale
Frequency Accuracy	± 0.01 % at 25°C ± 0.001 %/°C
Frequency Resolution	40 Hz to 99.99 Hz: 0.01 Hz 100 Hz to 999.9 Hz: 0.05 Hz 1000 Hz to 5000 Hz: 0.5 Hz
Phase Accuracy, Phase-to-Phase Balanced Linear Resistive Load	$\pm 1^\circ$, 40 Hz to 1 kHz, plus $\pm 1^\circ$ /kHz above 1 kHz
Phase Angle Resolution	0.1°
Remote Output Voltage Sense	5 Vrms total lead drop, max

Environmental	
Operating Temperature	0°C to 45°C (32°F to 113°F)
Storage Temperature	-40°C to 70°C (-40°F to 158°F)
Cooling	Air is drawn in from the top, bottom, and sides and exhausted through the rear
Humidity (Non-condensing)	0 to 85% at 25°C (77°F); derate to 50% at 40°C (104°F)
Altitude	Operating 10,000 ft, non operating 40,000 ft
Physical	
Dimensions	Width: 19" (483 mm) Height: 8.75" (222 mm) Depth: 23.5" (597 mm)
Weight	SW 1750A - 73 lbs (33.1 kg), SW 3500A - 100 lbs (45.4 kg), SW 5250A - 127 lbs (57.5 kg)
Shipping Weight - US	SW 1750A - 160 lbs (73 kg), SW 3500A - 180 lbs (82 kg), SW 5250A - 200 lbs (91 kg)
Note	Note: 10.5, 15.75 and 21 kVA systems, dimension and weight are approximately x2, x3 and x4 SW 5250A Specifications
Measurements (optional)	
Measurements	Phase to Neutral rms Output Voltages, Phase to Phase Voltages, 1 ϕ to 3 ϕ rms Output Currents, Peak Current, Output Frequency, 1 ϕ to 3 ϕ Power, 1 ϕ to 3 ϕ VA, Power Factor of 1 ϕ or 3 ϕ Loads, Output Phase Angles Relative to Phase A
Measurement Capability	4.5 Digit Analog to Digital Measurement System with .01% of full scale resolution unless otherwise noted.
Calibration Interval	12 months
Temperature Range for specified Accuracy	25°C to \pm 5°C unless otherwise noted
Phase to neutral rms voltage measurement	Valid for phases A, B and C (use phase A for Parallel Mode) <ul style="list-style-type: none"> • Range: 0V to 350V plus sign bit for DC range • Accuracy: \pm0.3% of range, DC or 47 Hz to 1 kHz; \pm0.5% of range, 40 to 47 Hz and for 1 kHz to 5 kHz
Phase to phase rms voltage	Calculated from Phase to Neutral voltages and phase angle <ul style="list-style-type: none"> • Range: 0V to 700V • Accuracy and Temperature Coefficient: The same as the Phase to Neutral voltage rms current measurement: Valid for phases A, B, and C (use phase A for Parallel Mode) • Range 1: 0A to 7.5A, plus sign bit for DC range; 3ϕ mode, 312V range • Range 2: 0A to 15A, plus sign bit for DC range; 3ϕ mode, 156V range • Range 3: 0A to 22.5A, plus sign bit for DC range; parallel mode, 312V range • Range 4: 0A to 45A plus sign bit for DC range; parallel mode, 156V range • Accuracy: \pm1.0% of range, DC or 40 Hz to 500 Hz; add \pm1.5%/kHz above 500 Hz of 4.0
Peak current measurement	Valid for phases A, B, and C (use phase A for Parallel Mode) <ul style="list-style-type: none"> • Range 1: 0A to 28A; 3ϕ mode, 312V range • Range 2: 0A to 56A; 3ϕ mode, 156V range • Range 3: 0A to 84A; parallel mode, 312V range • Range 4: 0A to 168A; parallel mode, 156V range • Accuracy: \pm5% of range, 40 to 500 Hz; add \pm1%/kHz, 500 Hz to 5 kHz
Power Measurement	Valid for phases A, B, and C. Up to 3 ϕ total power and parallel mode (use phase A for Parallel Mode) <ul style="list-style-type: none"> • Range 1: 0 kW to 1.8 kW; 3ϕ mode • Range 2: 0 kW to 5.6 kW; parallel mode and total 3ϕ power • Accuracy: \pm2.5% of range, DC or 40 to 500 Hz for crest factors <2.0. Add \pm1% for crest factors up to 4.0. Add \pm1%/kHz above 500 Hz
VA Measurement	Valid for phases A, B, and C. Up to 3 ϕ total VA and parallel mode (use phase A for Parallel Mode) <ul style="list-style-type: none"> • Range 1: 0 kW to 1.8 kVA; 3ϕ mode • Range 2: 0 kW to 5.6 kVA; parallel mode and total 3ϕ power • Accuracy: \pm2.5% of range, DC or 40 to 500 Hz for crest factors <2.0. Add \pm1% for crest factors up to 4.0. Add \pm1%/kHz above 500 Hz
Power Factor	Valid for phases A, B, and C (use phase A for Parallel Mode) The Power Factor is calculated from the Power and VA measurements <ul style="list-style-type: none"> • Range: 0 to 1.00 • Accuracy: \pm5% of range at full power, DC or 40 to 500 Hz for crest factors <2.0. Add \pm2% for crest factors up to 4.0. Add \pm1%/kHz above 500 Hz
Frequency Measurement	Frequencies are calculated based on output zero crossing time measurements <ul style="list-style-type: none"> • Resolution: Frequency is displayed to 5 digits max; leading zeros are blanked. Displayed resolution is 0.01 Hz • Accuracy: \pm0.5% of reading, at 10% to full output voltage, 0°C to 45°C
Phase Measurement	Valid for phases A, B, and C relative to each other <ul style="list-style-type: none"> • Resolution: \pm1° • Accuracy: \pm2°, 40 to 500 Hz; add \pm2%/kHz above 500 Hz. For sine wave, balanced resistive load, 10% to 100% of voltage measurement range, 0°C to 45°C

SW Series : Product Specifications

Waveform Specifications

Waveshape Libraries	50 factory supplied in ROM; storage available for up to 50 user created in nonvolatile RAM
Front Panel Setups	A total of 50 user created steady-state waveforms, with amplitude, frequency, phase angle and current limit parameters
Sequencing Library	1000 user created segments stored in non-volatile RAM. Segments include waveshape, amplitude, frequency, phase angle, time (from 1 ms to 1000 seconds), or number of cycles.
MIL-STD-704	Transient Library

Protection And Safety

Overvoltage Shutdown	Programmable for 15V to 255V peak, 156V range; 30V to 510V peak, 312V range
Programmable Current Limit Shutdown	Settable to 1% of range (0.5A to 13A for 156V range; 0.5A to 6.5A for 312V range)
Programmable Current Limit with Timed Shutdown	Settable to 1% of range: the timeout is settable from 100 ms to 10s.
Programmable Constant Current	Settable to 1% of range (0.5A to 13A for 156V range; 0.5A to 6.5A for 312V range). For all current accuracies $\pm 1\%$ of fullscale, add $\pm 1.5\%/kHz$ above 500 Hz. For paralleled amplifiers, add $\pm 1\%$
Over temperature Shutdown	Automatic, not programmable

Regulatory Compliance	<ul style="list-style-type: none"> • EN 61010 • EN 55011 • UL 3111 • EN 50082-2 • EN 61000-4-3, EN 61000-4-4 • FCC Part 15, Class A • CE Mark <p>Designed to meet:</p> <ul style="list-style-type: none"> • EN 61010 • EN 55011 • UL 3111 • EN 50082-2 • EN 61000-4-3, EN 61000-4-4 • FCC Part 15, Class A
-----------------------	---

Operating Area

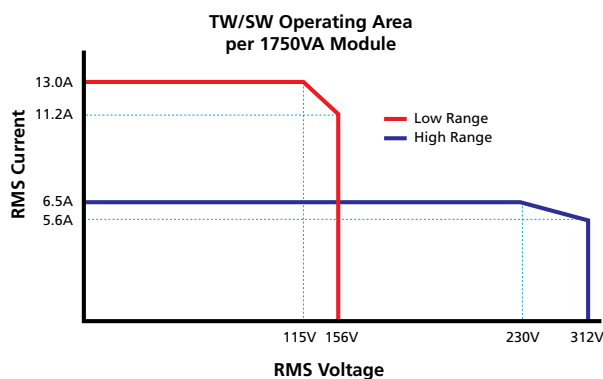
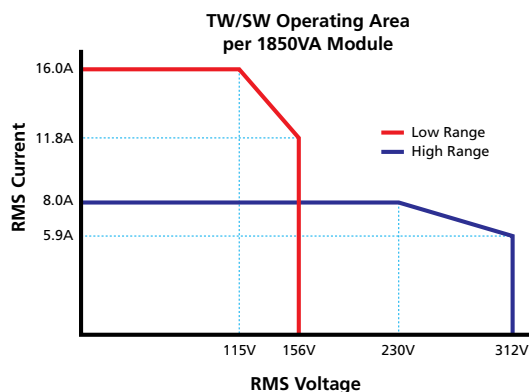

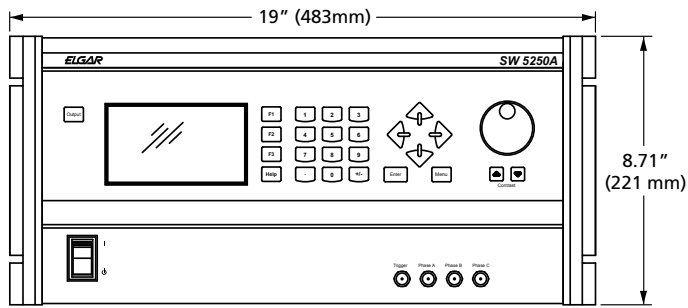

Front View

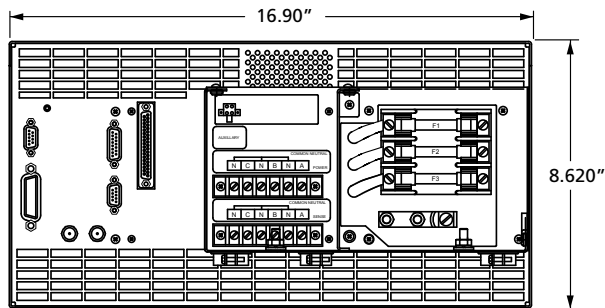

Rear View

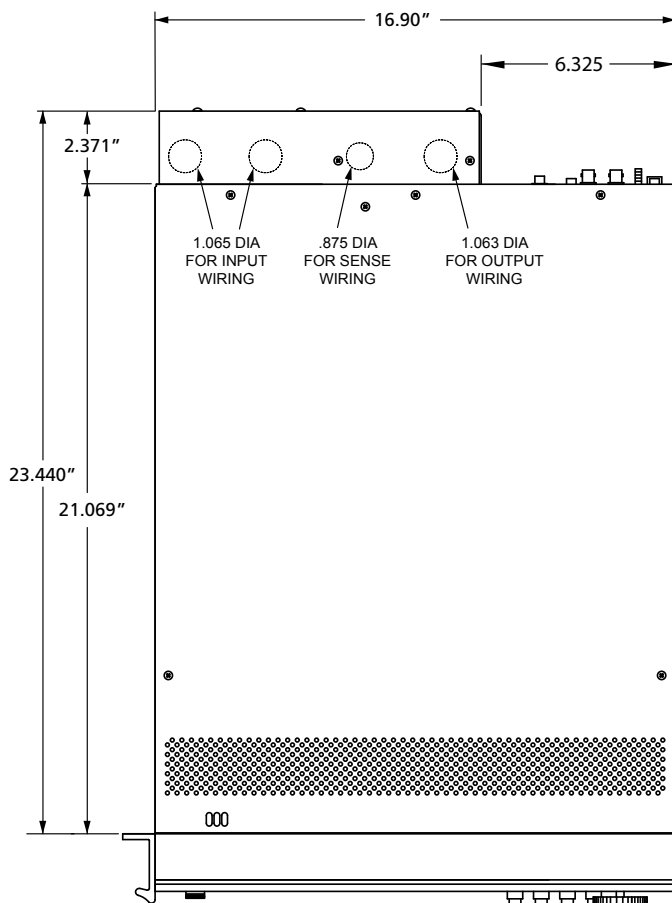

Top View

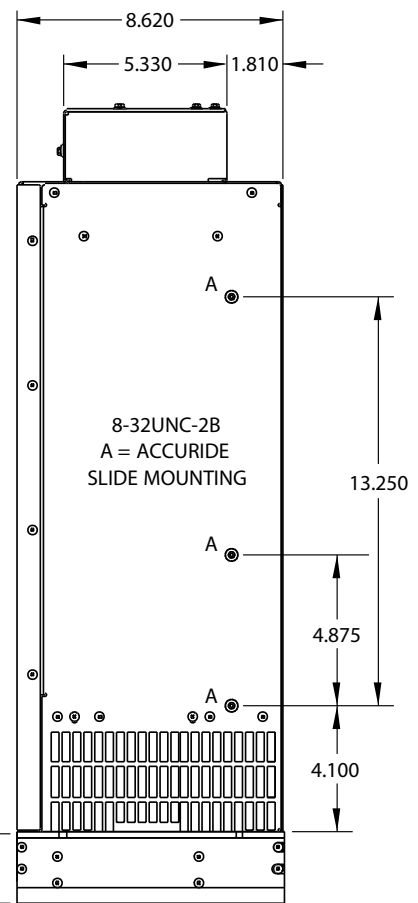

Side View

SW Series

Model Number Description

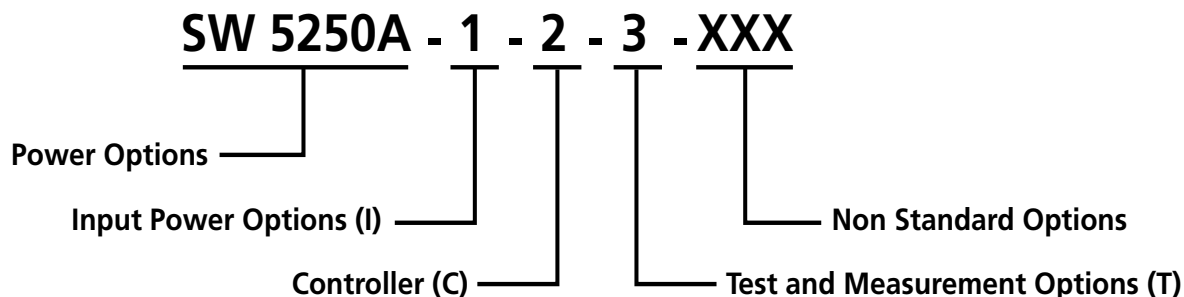

Ordering Information

Model Number	Output Power Rating
SW 1750A	1750 VA
SW 1850A	1850 VA
SW 3500A	3500 VA
SW 3700A	3700 VA
SW 5250A	5250 VA
SW 5250L	5250 VA (limit frequency to 595 Hz)
SW 5550A	5550 VA

Ordering Information

Model Number	Output Power Rating	5250 Master / Slave Configuration
SW 10500 / 11100	10.5 kVA / 11.1 kVA	1 master SW 5250 & 1 Slave SW 5250
SW 15750 / 16650	15.75 kVA / 16.65 kVA	1 master SW 5250 & 2 Slave SW 5250
SW 21000 / 22200	21 kVA / 22.2 kVA	1 master SW 5250 & 3 Slave SW 5250

Options

Input Power Options (I)	1: Rectifier 87-264VRMS (L-L), 3-wire 2: Rectifier International, 342-457 VRMS (L-L), 4-wire 3: Power factor corrected, 187-264 VRMS (L-L), 3-wire 4: Power factor corrected, 342-457 VRMS (L-L), 4-wire (option for single phase operation) 6: Power factor corrected with CE mark (SW 10500 and 15750 models only), 342-457 VRMS (L-L), 4-wire
Controller Options (C)	3: GPIB
Test and Measurement Options (T)	1: No Test and Measurement 2: Standard Test and Measurement
Non-Standard Options	102: Low Speed Fan 131: 2Hz-8kHz operation

Accessories

5161393-01	5V or 26V, or 0.25A auxiliary AC output
881-985-35	Waveform DSP II Software
A162000-01	Rackmount Kit (1 required for each 5250VA)
990-323-90	L Brackets (2 required for each 5250VA)
Certificate of Calibration	(models up to SW21000)

© 2009 AMETEK Programmable Power All rights reserved. AMETEK Programmable Power is the trademark of AMETEK Inc., registered in the U.S. and other countries. Elgar, Sorensen, California Instruments, and Power Ten are trademarks of AMETEK Inc., registered in the U.S.